

Habitat Quantification Tool (HQT)  
SCIENTIFIC METHODS  
DOCUMENT

*January 2025*

*Version 2.0*

## ACKNOWLEDGEMENTS

This HQT Scientific Methods document was developed for the State of Nevada Department of Conservation and Natural Resources and Nevada Sagebrush Ecosystem Council (SEC). The project was funded by Question 1 Bond funding through a contract with the State of Nevada Natural Heritage Program.

This HQT Scientific Methods document is based on the scientific methods document developed for the Colorado Habitat Exchange. Significant appreciation is given to the Colorado Science Team that spent several years developing the Colorado Scientific Methods Document.

The following individuals provided invaluable guidance and direction throughout development of the latest version of this HQT Scientific Methods document to ensure it accurately reflects the unique ecological systems and Greater Sage-grouse needs in the State of Nevada.

### TECHNICAL REVIEW GROUP (TRG)

Lara Enders, U.S. Fish and Wildlife Service  
 Steve Abele, U.S. Fish and Wildlife Service  
 Genevieve Skora, U.S. Fish and Wildlife Service  
 Cheva Gabor, U.S. Forest Service  
 Timothy Bowden, Bureau of Land Management  
 Carolyn Sherve, Bureau of Land Management  
 Anthony Bush, Natural Resources Conservation Service  
 Jasmine Kleiber, Nevada Department of Wildlife  
 Katie Andrle, Nevada Department of Wildlife  
 Justin Small, Nevada Department of Wildlife  
 Astrea Strawn, Nevada Department of Wildlife  
 Shawn Espinosa, Nevada Department of Wildlife\*  
 Dr. Peter Coates, U.S. Geological Survey  
 Kristie Boatner, U.S. Forest Service\*

Quinn Young, Bureau of Land Management\*  
 Holley Kline, Bureau of Land Management\*  
 Ronald Baxter, U.S. Fish & Wildlife Service\*  
 Sandra Brewer, Bureau of Land Management\*  
 Dr. Jeanne Chambers, U.S. Forest Service,  
 Rocky Mountain Research Station\*  
 Dr. Barry Perryman, University of Nevada,  
 Reno\*  
 Dr. James Sedinger, University of Nevada,  
 Reno\*  
 Dr. Sherman Swanson, University of Nevada,  
 Reno\*  
 Dr. Mark Ricca, U.S. Geological Survey\*  
 Eoin Doherty, Environmental Incentives, Inc.  
 (Facilitator)\*  
 Dr. Steven Courtney, WEST, Inc. (Facilitator)\*

### NEVADA SAGEBRUSH ECOSYSTEM TECHNICAL TEAM & OTHER STATE STAFF

Kathleen Steele, Program Manager	Sarah Hale, Nevada Division of State Lands	Skyler Monaghan, Nevada Department of Agriculture
Cheyenne Acevedo, Nevada Department of Wildlife	Casey Adkins, Nevada Division of Forestry	

\*Indicates previous involvement in their respective group or team (TRG is a dynamic group, participation is dependent on availability of professionals, relevant topics, and area of expertise of participants)

The consulting team that developed this HQT Scientific Methods document included Environmental Incentives, LLC and EcoMetrix Solutions Group, LLC.

Updated and maintained by the Nevada Sagebrush Ecosystem Technical Team.  
 Established by Environmental Incentives, LLC. South Lake Tahoe, CA.

### SUGGESTED CITATION:

State of Nevada. Department of Conservation and Natural Resources. Sagebrush Ecosystem Program. 2025. Nevada Habitat Quantification Tool Scientific Methods Document v2.0.



## CCS DOCUMENTS & TOOLS

Several tools and documents are used to describe and operationalize the CCS. The primary tools and documents are summarized below and the most recent versions are available on the [CCS website](#) or through the Administrator.

### Conservation Credit System Manual

- Provides guidance and information needed to participate in the Credit System including an overview of the program, policy, and technical requirements, and operational protocols.
- Audience:
  - Administrator
  - Credit Developers and Credit Buyers
  - Technical Support Providers
- Informs the User's Guide and Calculator

### HQT Scientific Methods Document

- Defines the attributes assessed to measure Greater Sage-grouse habitat conditions and document the rationale for the attributes selected
- Audience:
  - Administrator
  - Science Contributors
- Informs the User's Guide and Calculator

### User's Guide

- Provides step-by-step guidance for efficiently and accurately calculating functional acres, credits, and debits for projects in the Credit System, including the desktop analysis and field data collections methods.
- Audience:
  - Administrator
  - Technical Support Providers
- Provides instructions for filling out the Calculator

### Calculator

- Calculates functional acres, credits, and debits for proposed and implemented projects.
- Audience:
  - Administrator
  - Technical Support Providers

# TABLE OF CONTENTS

<b>1.0 Introduction .....</b>	<b>8</b>
<b>2.0 Overview of the Habitat Quantification Tool.....</b>	<b>9</b>
2.1 Species Habitat Quality & Species Performance.....	9
2.2 Anthropogenic Disturbances.....	9
2.3 Framework for Quantifying Greater Sage-Grouse Habitat Function.....	9
<b>3.0 Habitat Quantification Methods &amp; Attributes.....</b>	<b>11</b>
3.0.1 Project Area & Map Units .....	12
3.0.2 Habitat Function & Functional Acres .....	13
3.0.3 Credits & Debits .....	13
3.1 Range-wide Scale (1 <sup>st</sup> Order).....	14
3.2 Landscape Scale (2nd Order).....	15
3.2.1 Management Category Importance.....	15
3.2.2 Meadow Ecosystem.....	17
3.2.3 Pinyon-Juniper Removal .....	18
3.3 Local Scale (3 <sup>rd</sup> Order) .....	20
3.3.1 Anthropogenic Disturbance .....	20
3.3.2 Habitat Suitability Index.....	24
3.3.3 Abundance & Space Use Index Score (ASUI) .....	25
3.3.4 Distance to Late Brood-Rearing Habitat.....	26
3.4 Site Scale (4 <sup>th</sup> Order) .....	29
3.4.1 Triggers.....	31
3.4.2 Scoring Curves .....	31
3.4.3 Attribute Weighting .....	32
3.4.4 Attributes Measured.....	32
3.4.5 Modification of Site-Scale Habitat Function .....	34
<b>4.0 Project Example.....</b>	<b>38</b>
<b>5.0 Limitations of the HQT .....</b>	<b>41</b>
<b>6.0 Appendices .....</b>	<b>43</b>
Appendix 1. Scoring Curves.....	44
Appendix 2. Monitoring & Adaptive Management.....	62
Tool Evaluation .....	62
CCS Management System .....	62
Appendix 3. HQT Development & Review.....	64
Internal Development & Review .....	64
Appendix 4. Sage-Grouse Response to Anthropogenic Disturbance Literature Review.....	66
Distance to Energy Development .....	66
Density of Energy Development.....	66
Mining .....	67

Noise.....67

Roads.....67

Railways.....68

Traffic.....68

Transmission & Powerlines.....69

Towers.....70

Urban Development.....71

Linear rights of way.....71

Other disturbance.....72

**References .....73**

**FIGURES**

Figure 1. Use of multiple scales for quantifying GRSG habitat function..... **Error! Bookmark not defined.**

Figure 2. Map units delineated within the project area for an example credit project.....12

Figure 3. First order use of multiple spatial scales for quantifying GRSG habitat function..... **Error! Bookmark not defined.**

Figure 4. BSU Area Map (Left) and WAFWA Management Zones. Nevada BSU and NDOW PMU (Right) .....14

Figure 5. Second order use of multiple spatial scales for quantifying GRSG habitat function .....15

Figure 6. Sagebrush Ecosystem Program’s Management Categories Map used to determine habitat importance at the landscape scale ..... **Error! Bookmark not defined.**

Figure 7. SEP map used to provide initial determination of areas of pinyon-juniper cover .....19

Figure 8. Third order use of multiple spatial scales for quantifying GRSG habitat function .....20

Figure 9. Example distance-decay curves with the y-intercept the weight and the x-intercept the distance associated with the anthropogenic disturbances.....21

Figure 10. Habitat function due to the indirect effects of anthropogenic disturbance on GRSG habitat in the area surrounding an example credit project site .....24

Figure 11. Habitat suitability related to the Spring HSI in the area surrounding an example credit project site .....25

Figure 12. Scoring curve and table for distance to lek attribute as modifier to breeding habitat function .....26

Figure 13. Effect of abundance and space use on breeding habitat function for an example credit project .....26

Figure 14. Scoring curve and table for distance to late brood-rearing habitat attribute as modifier to breeding habitat function.....27

Figure 15. Effect of distance to late brood-rearing habitat on breeding habitat function for an example credit project .....27

Figure 16. Local-scale attributes are measured in a GIS and combined to calculate local-scale habitat function for each seasonal sage-grouse habitat type.....28

Figure 17. Fourth order use of multiple spatial scales for quantifying GRSG habitat function.....29

Figure 18. Conceptual model depicting GRSG life history requirements at the site scale (4th order) .....30

Figure 19. Scoring curve and table for sagebrush canopy cover in breeding habitat.....32

Figure 20. Scoring curve and table for invasive annual grass canopy cover as a modifier for breeding and late brood-rearing habitat .....34

Figure 21. Scoring curve and table for scoring late brood-rearing habitat based on distance to sagebrush cover.....36

Figure 22. Example credit project and map units .....38

Figure 23. Scoring curve and table for sagebrush copy cover as a modifier for breeding habitat .....44

Figure 24. Scoring curve and table for total shrub canopy cover as a modifier for breeding habitat .....45

Figure 25. Scoring curve and table for perennial forb canopy cover (arid conditions) as a modifier for breeding habitat .....46

Figure 26. Scoring curve and table for perennial forb canopy cover (mesic-shrub & meadow systems) as a modifier for breeding habitat.....47

Figure 27. Scoring curve and table for forb species richness (arid conditions) as a modifier for breeding habitat.....48

Figure 28. Scoring curve and table for forb species richness (mesic-shrub & meadow systems) as a modifier for breeding habitat .....49

Figure 29. Scoring curve and table for perennial forb canopy cover (arid-conditions) as a modifier for late brood-rearing habitat .....50

Figure 30. Scoring curve and table for perennial forb canopy cover (mesic-shrub systems) as a modifier for late brood-rearing habitat .....51

Figure 31. Scoring curve and table for perennial forb canopy cover as a modifier for late brood-rearing habitat .....52

Figure 32. Scoring curve and table for forb species richness (arid conditions) as a modifier for late brood-rearing habitat .....53

Figure 33. Scoring curve and table for forb species richness (mesic-shrub & meadow systems as a modifier for late brood-rearing habitat .....54

Figure 34. Scoring curve and table for perennial grass canopy cover (arid conditions) as a modifier for late brood-rearing habitat .....55

Figure 35. Scoring curve and table for perennial grass canopy cover (mesic-shrub systems) as a modifier for late brood-rearing habitat .....56

Figure 36. Scoring curve and table for perennial grass canopy cover (meadow systems) as a modifier for late brood-rearing habitat .....57

Figure 37. Scoring curve and table for sagebrush height (dominantly big sagebrush) as a modifier for winter habitat .....58

Figure 38. Scoring curve and table for sagebrush height (dominantly low or black sagebrush) as a modifier for winter habitat .....59

Figure 39. Scoring curve and table for sagebrush canopy cover (dominantly big sagebrush) as a modifier for winter habitat .....60

Figure 40. Scoring curve and table for sagebrush canopy cover (dominantly low or black sagebrush) as a modifier for winter habitat .....61

Figure 41. Steps in the credit system adaptive management process.....63

**TABLES**

Table 1. Example calculation of functional acres for a single map unit ..... 13

Table 2. Example map unit calculation (landscape scale) ..... 18

Table 3. Anthropogenic features considered by the credit system with assigned weights and distances .....22

Table 4. Example map unit calculation (local scale) .....28

Table 5. Description of vegetation attributes measured and attribute weight .....33

Table 6. Example map unit Calculation (site scale).....36

Table 7. Pre-modified site-scale function example.....37

Table 8. Attribute measurements, habitat function, and functional acre values for breeding habitat function.....39

Table 9. Attribute measurements, habitat function, and functional acre values for late brood-rearing habitat function .....39

Table 10. Attribute measurements, habitat function, and functional acre values for winter habitat function.....40

## 1.0 INTRODUCTION

---

The Nevada Greater Sage-grouse Habitat Quantification Tool (HQT) Scientific Methods Document outlines a scientific approach to quantifying function for Greater Sage-grouse (*Centrocercus urophasianus*; hereafter, GRSG) habitat in the State of Nevada. The HQT can be applied to evaluate GRSG habitat function for various purposes, including assessing the outcomes of conservation and development projects and monitoring anthropogenic and natural disturbances. The Nevada Conservation Credit System (Credit System) uses the HQT to determine the credits generated by conservation projects and the debits generated by anthropogenic disturbances. It also uses the HQT to prioritize credit and debit projects in areas most beneficial to GRSG and to track the Credit System's contribution to GRSG habitat and population objectives over time.

This HQT Scientific Methods Document provides a detailed description of the attributes measured by the HQT, the methods used to assess those attributes, and the supporting rationale for their selection (e.g., peer-reviewed literature, gray literature, expert opinion). It also outlines the scoring approach used to generate a single GRSG habitat function score based on site-specific measurements. Additionally, an example project is included to demonstrate the application of the scoring approach.

### USERS AND USES

The primary audiences of the HQT Scientific Methods Document are the Credit System Administrator (Administrator) and science contributors. The Administrator will use this document as the foundation for programmatic improvement of the HQT and will update it as the HQT is improved over time. Other stakeholders may refer to the HQT Scientific Methods Document to understand the scientific principles behind the HQT, while scientists and other experts may be asked to review it and provide recommendations for improving the HQT.

Although the HQT is specifically designed for use within the Credit System, it could also support other GRSG conservation efforts in Nevada. For instance, it could guide the allocation of public or non-governmental funding for GRSG conservation projects outside the Credit System and quantify the benefits of future conservation actions for GRSG.

### DEVELOPMENT PROCESS

The HQT is built on a well-established, academically supported framework derived from the Habitat Assessment Framework by Stiver et al. (2015) and described in this document. The initial version of the HQT was developed in 2014 in collaboration with the Sagebrush Ecosystem Technical Team, the Sagebrush Ecosystem Program, Environmental Incentives, Inc., and EcoMetrix Solutions Group. The GRSG Habitat Quantification Tool Scientific Methods Document, developed for the Colorado Habitat Exchange, served as the foundation for this document. Environmental Incentives convened a group of local biologists and rangeland ecologists, known as the Technical Review Group (TRG), to revise the methods, attributes, and scoring curves to reflect the best available scientific understanding of GRSG in Nevada.

---

## 2.0 OVERVIEW OF THE HABITAT QUANTIFICATION TOOL

---

The HQT is a scientific approach for assessing GRSG habitat function and conservation outcomes specific to GRSG. The HQT's primary purpose is to quantify GRSG habitat function at a given location, based on the specific ecological needs. The HQT uses a set of measurements and methods applied at multiple spatial scales to evaluate criteria related to GRSG habitat function.

---

### 2.1 SPECIES HABITAT QUALITY & SPECIES PERFORMANCE

---

A species' habitat represents a combination of resources (e.g., food, shelter, and water) and environmental conditions that support survival and reproduction (Morrison et al. 2007). A species' Habitat quality can vary, influencing its capacity to support survival and reproduction over time (i.e., function). The HQT approach assumes a direct relationship between availability of high-quality species' habitat and population resiliency. Conversely, poor-quality species' habitat is assumed to result in low survival and reproduction (Van Horne 1983), leading to reduced population resiliency. While marginal species' habitat may support some level of occupancy, it can still result in low survival or reproduction, which diminishes population resiliency, and likely contributes to population declines.

As with many ecological processes, species' habitat selection occurs at multiple spatial scales, with individuals selecting locations based on different features at each scale (Johnson 1980, Orians and Wittenberger 1991, Fuhlendorf and Smeins 1996, Fuhlendorf et al. 2002, Morrison et al. 2007). This is true for vegetation, as birds may first perceive vegetation structure at a large, landscape scale before selecting more specific locations based on finer-scale vegetation composition and other factors (Smith et al. 2020). Addressing the multiple spatial scales relevant to a species' habitat use and performance is critical for effective and efficient conservation and management (Johnson 1980).

---

### 2.2 ANTHROPOGENIC DISTURBANCES

---

In addition to vegetation structure and composition, research consistently indicates that GRSG select their habitat based on the presence or absence of nearby anthropogenic disturbances. Key demographic rates, such as nesting success, may be influenced by proximity to anthropogenic disturbances (e.g., decreased nesting success due to change in predator community in proximity to powerlines; see [Appendix 4](#) for a review of literature on the effects of anthropogenic disturbance on GRSG). The presence of anthropogenic disturbances surrounding a site can reduce the integrity of the site—even if the site has otherwise beneficial characteristics for GRSG. This effect is known as an 'indirect effect'. Research suggests that the indirect effects on GRSG are based on the proximity to the anthropogenic disturbance; as the distance from the disturbance increases, the effect on GRSG decreases (Manier 2014). The HQT accounts for the indirect effects associated with anthropogenic disturbance by applying scientifically informed distance-decay curves to GRSG habitat near disturbance when quantifying GRSG habitat function.

---

### 2.3 FRAMEWORK FOR QUANTIFYING GREATER SAGE-GROUSE HABITAT FUNCTION

---

The HQT was developed to account for GRSG habitat characteristics - both natural and anthropogenic - that influence selection across multiple scales. These characteristics are based on different orders of selection (Johnson 1980, Stiver et al. 2015), which represent four spatial scales at which ecosystem attributes influence where GRSG reside and obtain resources necessary for survival and reproduction. Johnson (1980, 2011) describes this hierarchical nature of selection as: "a selection process will be of

higher order than another if it is conditional upon the latter.” For example, conditions at the site may support successful breeding and early brood-rearing, but if late brood-rearing habitat is not accessible within the landscape, the value of that area is diminished or negligible. The HQT assesses GRSG habitat quality across these four orders.

**Range-wide Scale (1st order):** Range-wide scale is the geographic range of the GRSG population in Nevada. An important objective at this scale is to evaluate the contribution of altered conditions resulting from site-level management actions to regional or statewide GRSG habitat and population conservation goals.

**Landscape Scale (2nd order):** Landscape scale selection determines the home range of a GRSG population or subpopulation. The purpose of measuring attributes at this scale is to provide a means of delineating the best areas for conservation and identifying where credit projects should be targeted, and development should be avoided.

**Local Scale (3rd order):** Local scale refers to seasonal GRSG habitats. Within their home range, GRSG select seasonal habitats according to their life cycle needs. Factors that affect GRSG use of, and movement between, seasonal use areas determine quality at this scale. Attributes are measured at the 3<sup>rd</sup> order to inform and incentivize management actions that meet the conservation goals prescribed at the 2<sup>nd</sup> order.

**Site Scale (4th order):** Site scale refers to vegetation structure and composition that provide for GRSG daily needs, including forage and cover. Measurements at this scale focus on vegetation attributes known to be important for GRSG and contribute to successful GRSG habitat selection (Connelly et al. 2000, 2003, Hagen et al. 2009, Bureau of Land Management 2015).

The use of multiple spatial scales results in a more ecologically comprehensive approach to broad-scale siting of anthropogenic features and conservation decisions in conjunction with site-based assessments of local environmental suitability conditions. Information provided at the respective scales can be used through either a top-down or a bottom-up manner. For example, using it in a top-down manner provides for effective conservation planning and targeting; applying the information in a bottom-up manner provides an essential perspective for understanding overall benefits and detriments to landscape integrity over time (**Error! Reference source not found.**).

### 3.0 HABITAT QUANTIFICATION METHODS & ATTRIBUTES

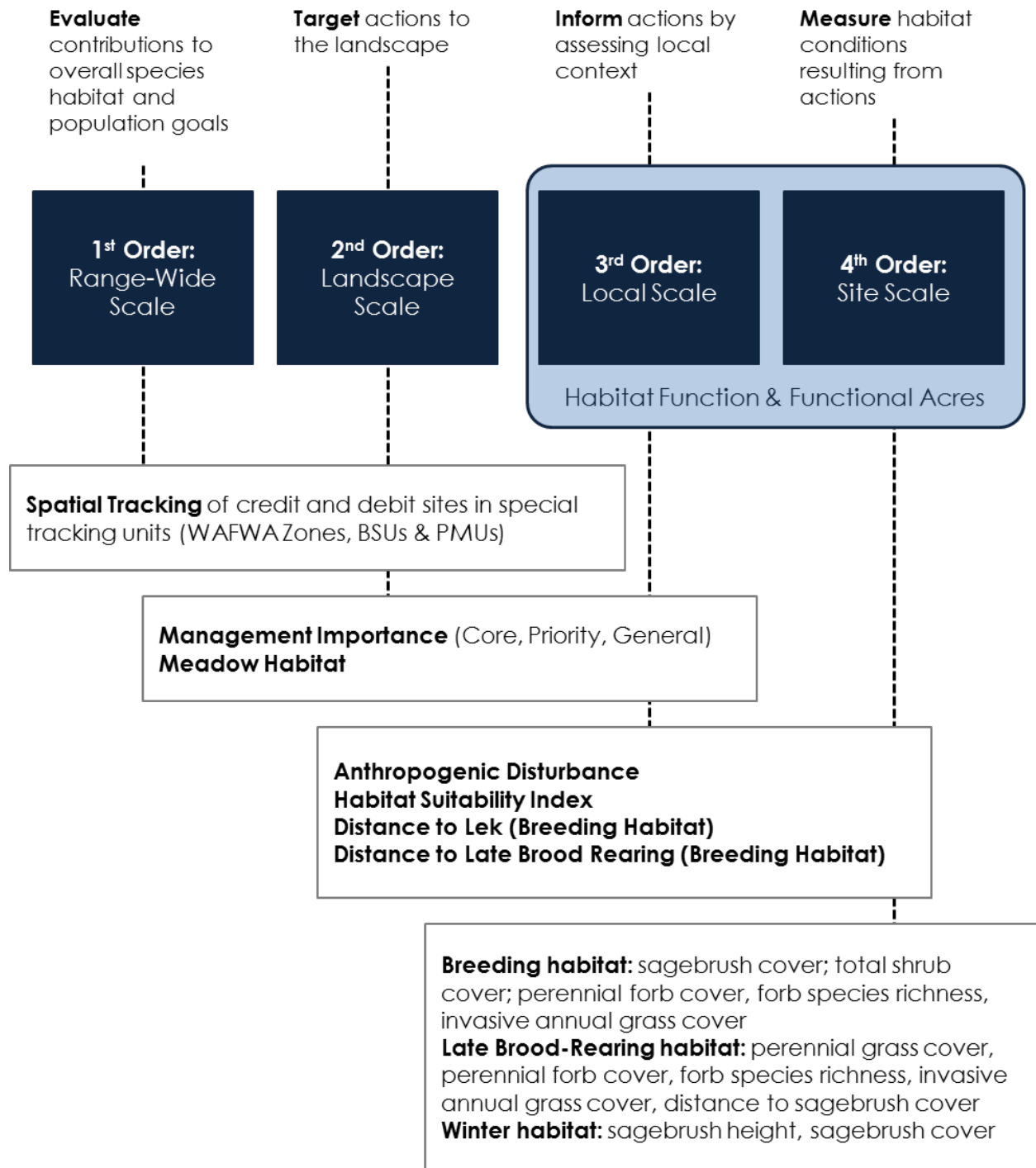

Figure 1. Use of multiple scales for quantifying GRSG habitat function

This section describes the attributes measured by the HQT at each of the four orders of selection (i.e., range-wide, landscape, local and site scales) to quantify GRSG habitat function and functional acres. GRSG habitat function and functional acres can be quantified using the HQT for multiple purposes, including:

**At a point in time** to understand the current condition of an area for GRSG.

**At multiple points in time** for the same area to quantify changes in GRSG habitat function and functional acres.

**To calculate credits and debits** associated with credit and debit projects in the Credit System. To calculate credits and debits, credit and debit baseline functional acres must be calculated as defined in the CCS Manual. Credits and debits represent functional acre difference relative to baseline functional acres, multiplied by a mitigation ratio based in part on attributes measured by the HQT at the landscape scale.

### 3.0.1 PROJECT AREA & MAP UNITS

GRSG habitat function should be quantified over a discrete area when calculating functional acres. Thus, the project area must be clearly defined. When quantifying GRSG habitat function for a conservation project (e.g., a credit project), the project area should include all GRSG habitat categories (HMA map) within the exterior boundaries of the project. When quantifying the direct and indirect effects of anthropogenic disturbance on GRSG habitat function (e.g., a debit project), the project area must include all GRSG habitat categories (HMA map) directly or indirectly affected by the disturbance. Indirect effects associated with anthropogenic disturbance are discussed in [Section 3.3.1 Anthropogenic Disturbance](#).

To facilitate the GRSG habitat assessment, the project area is divided into map units (Figure 2): subdivisions of the project area that are delineated based on variation in vegetative, soil, and ecological site characteristics. Map units identify areas containing similar attributes that are assessed by the HQT, such as sagebrush canopy cover, forb abundance, and distance to sagebrush cover. Guidance for delineating map units within a credit or debit site is provided in the CCS User's Guide. All attributes are measured individually for each map unit and all map units are scored separately. Map Unit 1 of an example credit project shown below will be assessed throughout this section to illustrate the scoring approach.

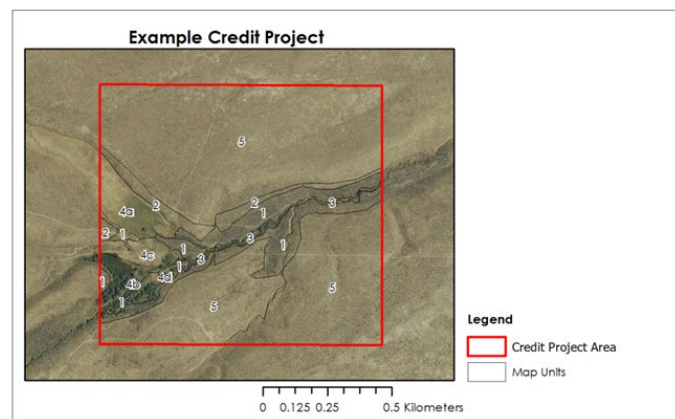

Figure 2. Map units delineated within the project area for an example credit project

### 3.0.2 HABITAT FUNCTION & FUNCTIONAL ACRES

The HQT generates local-scale function and site-scale function for each seasonal GRSG habitat type. The product of the local-scale function and site-scale function determines overall function for each seasonal GRSG habitat type for a map unit. For each seasonal GRSG habitat, the overall function is multiplied by the acreage of the map unit to produce a functional acre value.

Table 1. Example calculation of functional acres for a single map unit

SEASONAL HABITAT TYPE	LOCAL-SCALE HABITAT FUNCTION	SITE-SCALE HABITAT FUNCTION	OVERALL HABITAT FUNCTION	ACRES	FUNCTIONAL ACRES
<b>Breeding</b>	38%	61%	23%	18	4.2
<b>Late Brood-Rearing</b>	36%	70%	25%	18	4.5
<b>Winter</b>	28%	64%	18%	18	3.2

#### SEASONAL GREATER SAGE-GROUSE HABITAT TYPES

The HQT focuses on three seasonal GRSG habitat types: breeding, late-brood rearing, and winter. The scoring process is repeated for each seasonal GRSG habitat type considered by the HQT. Attributes must be measured during the permissible window for field data collection, except for attributes only used to score winter GRSG habitat which can be measured at any time, to ensure that function and functional acres are quantified correctly.

#### LANDSCAPE-SCALE ATTRIBUTES

Landscape-scale attributes are measured to provide information for targeting management actions on the landscape; they are not a component of the functional acre calculation for a site. They are incorporated into the quantification of credits and debits through the mitigation ratio defined in the CCS Manual (see *Section 2.2.3 Mitigation Ratio*).

### 3.0.3 CREDITS & DEBITS

To calculate credits or debits, credit or debit baseline functional acres are calculated as defined in the CCS Manual (see *Section 2.3.4: Calculating Credit Baseline Greater Sage-grouse Habitat Function* and *Section 2.5.5: Calculating Debit Baseline Greater Sage-grouse Habitat Function* in the CCS Manual for credit and debit projects respectively). Credits and debits are calculated from the difference between post-project functional acres (i.e., functional acres present after the debit or credit project is implemented) and the credit or debit baseline functional acres, respectively. A mitigation ratio is applied to the difference in functional acres for each map unit based in part on attributes measured at the landscape scale (see *Section 2.2.2: Mitigation and Proximity Ratios* in the CCS Manual). See the CCS Manual (*Section 2.2: Habitat Quantification and Credit and Debit Calculation*) for more information on calculating credits and debits.

The following sections describe the attributes measured at each scale, the rationale for the attributes selected, the methods for measuring each attribute, and the process for translating attribute measurements into scores that are used to calculate GRSG habitat function and functional acres. An example map unit will be used to illustrate the process. For a complete, step-by-step description of the scoring process used by the HQT, please see the *CCS User's Guide*.

### 3.1 RANGE-WIDE SCALE (1<sup>ST</sup> ORDER)

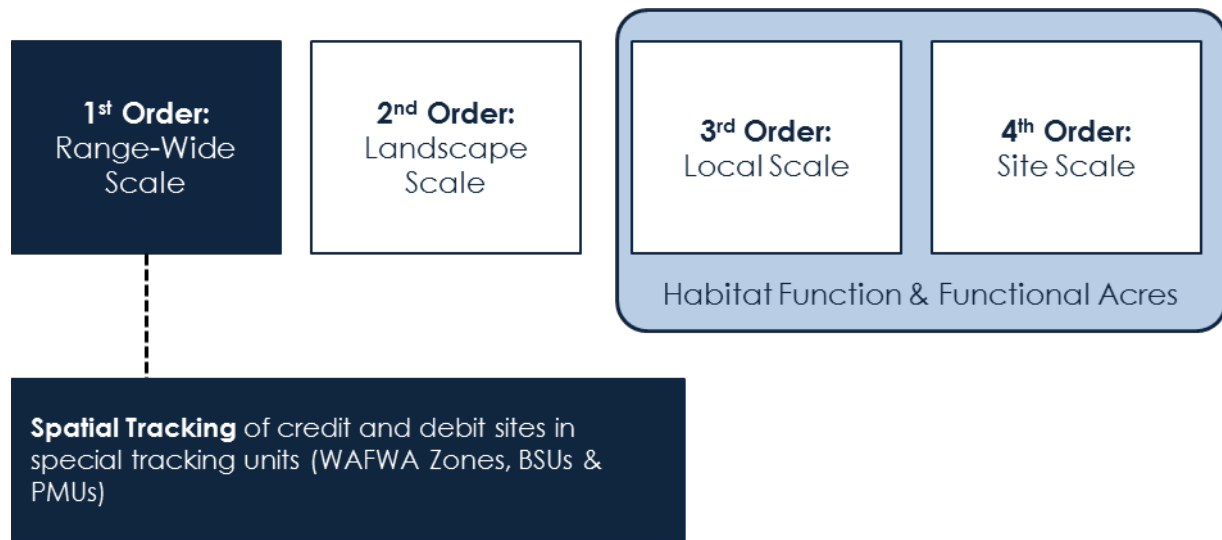

Figure 3. First order use of multiple spatial scales for quantifying GRSG habitat function

#### GEOGRAPHIC SCOPE

The Credit System's geographic scope is the mapped Biologically Significant Units (BSUs) shown in Figure 4 that were developed by the Nevada Department of Wildlife. Documented changes to the estimated range will be tracked and incorporated into the HQT over time through the CCS Management System described in the *CCS Manual*.

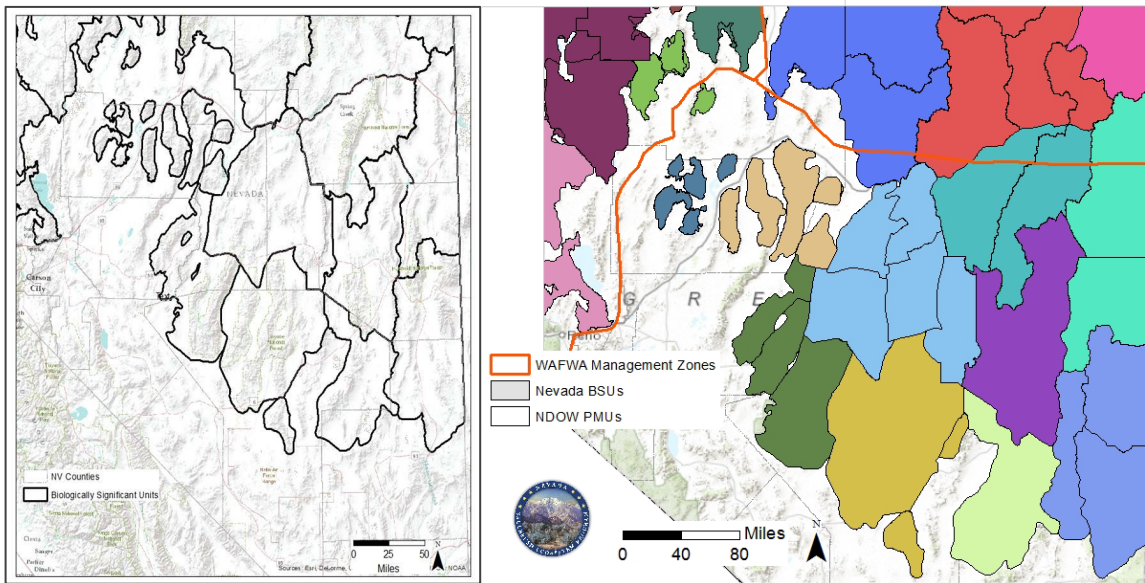

Figure 4. BSU Area Map (Left) and WAFWA Management Zones, Nevada BSU and NDOW PMU (Right)

#### SPATIAL TRACKING

The Credit System tracks the location of credit and debit sites in spatial tracking units. Spatial tracking units include Nevada Department of Wildlife Population Management Units (PMUs), Nevada Biologically Significant Unites (BSUs) and Western Association of Fish and Wildlife Agencies Management Zones (WAFWA Zones). PMUs are used to understand the functional acre change to each population, BSUs are used to understand the functional acre change to connected regional populations, and WAFWA Zones are used to understand the functional acre change to populations connected through dispersal.

### 3.2 LANDSCAPE SCALE (2ND ORDER)

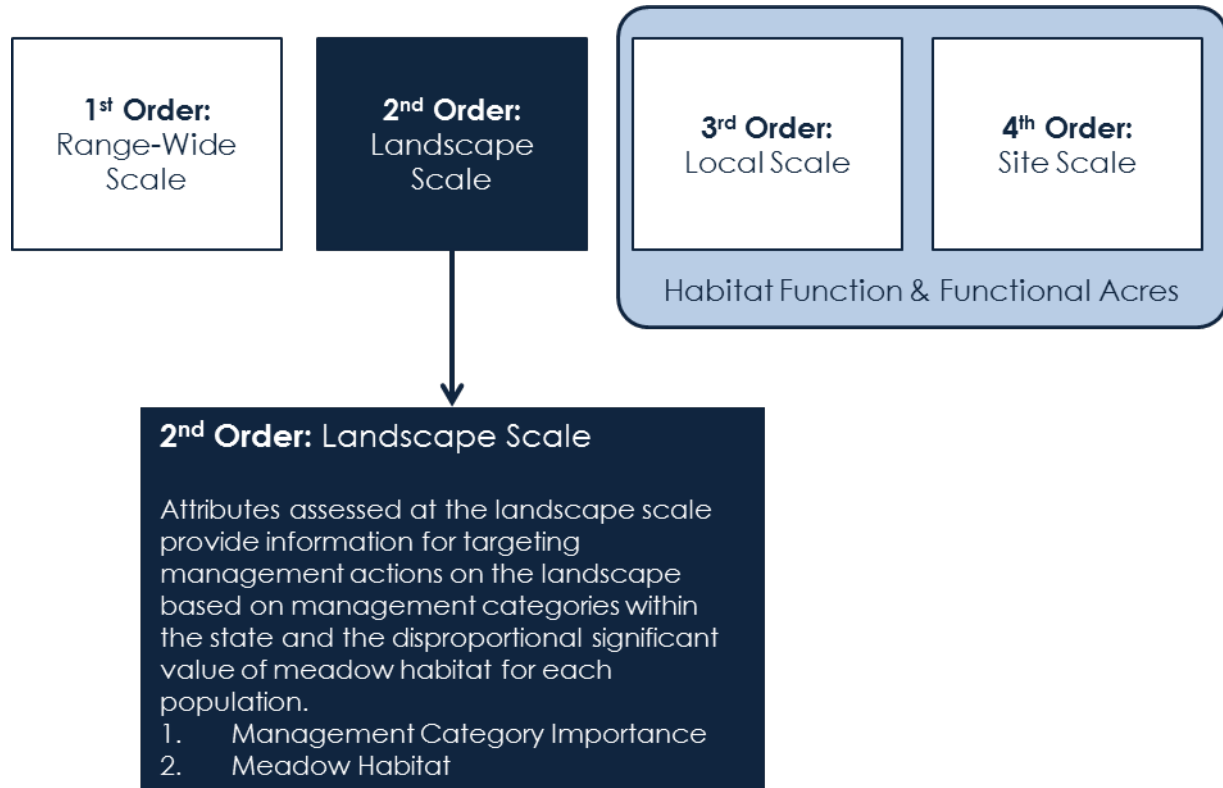

Figure 5. Second order use of multiple spatial scales for quantifying GRSG habitat function

#### 3.2.1 MANAGEMENT CATEGORY IMPORTANCE

The Sagebrush Ecosystem Program’s Management Categories map is used to determine management category importance (Figure 6). The map delineates three GRSG habitat management categories based on the intersection of modelled suitability and GRSG space use: Priority Habitat Management Area (PHMA), General Habitat Management Area (GHMA), and Other Habitat Management Area (OHMA).

Habitat Management Area categories are defined as followed by Milligan et al. 2024:

**Priority+ habitat management areas (PHMA+ or priority+):** Not used in the HQT, but provided as guidance for restoration. Source habitat for any reproductive life stage within the high-use ASUI class. This example habitat management category was intended to capture the best sage-grouse habitat with high certainty of current occupancy.

**Priority Habitat Management Area (PHMA):**

The intersection between categorized habitat selection classes (high, moderate, and low) and the high-use ASUI class, all source areas for any reproductive life stage within the low ASUI class, and all areas within 500 m of lek locations. This example habitat management category was intended to capture areas that support sage-grouse with a high certainty of current occupancy, the best source habitat regardless of occupancy, and lekking sites. The reasoning behind this second criteria was that including source habitat that may not currently have high occupancy can help promote conservation actions that curb decades of population declines, such as translocation, restoration, or improvements to connectivity between seasonal use areas. We included the third criteria to encompass lek locations which may not be appropriately captured within seasonal or life stage models but are critical for reproduction, with a 500-m buffer to capture satellite leks.

**General Habitat Management Area (GHMA):** the intersection between high habitat selection with the low ASUI class, and areas considered non-habitat based on the composite habitat selection map but within high ASUI areas. Specifically, these areas include high-quality habitat with low potential for occupancy given the current distribution of sage-grouse and potentially occupied areas in low-quality habitat that could be important for populations, such as corridors of low-quality habitat connecting isolated high-quality habitats. Occupied areas that contain low-quality habitat can also be identified as high priority for conservation action, with potential to improve population performance (for example, through native vegetation restoration or enhancement).

**Other Habitat Management Area (OHMA):** areas with moderate habitat selection within the low ASUI class. This represents areas used less frequently by sage-grouse where conditions may still be conducive for occupancy.

Predictions of GRSG occurrence based on space use models and indices in combination with GRSG habitat suitability models and indices (Doherty et al. 2010, Coates et al. 2014, 2020, Milligan et al. 2024) provide valuable information regarding the relative importance of areas to GRSG. This information can be used to prioritize areas for different management scenarios and aid decision making processes across the landscape. This information is used by the Credit System to inform the Credit System mitigation ratio applied to each map unit, see the CCS Manual for more information.

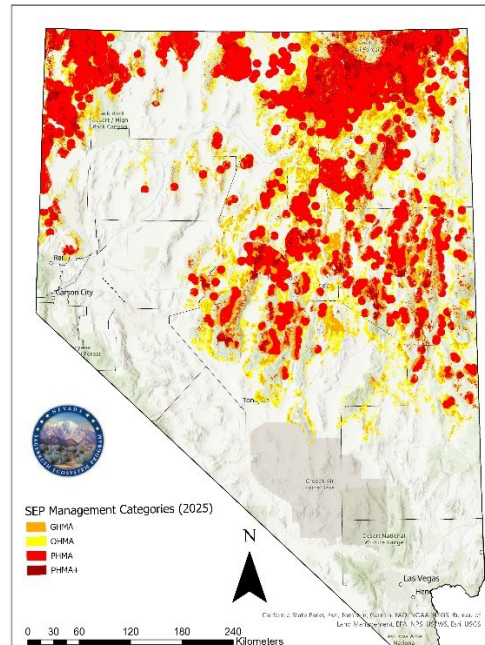

Figure 6. Sagebrush Ecosystem Program's Management Categories Map used to determine habitat importance at the landscape scale

### 3.2.2 MEADOW ECOSYSTEM

GRSG typically move among breeding, late brood-rearing, and winter habitat to meet resource requirements during different phases of their life cycle. If one or more seasonal GRSG habitats is impacted to the point that it can no longer support the corresponding life cycle phase, then the entire area is potentially no longer suitable for GRSG. However, information is currently lacking on how much of a particular seasonal habitat type is required to fulfill the corresponding life cycle phase and how to quantify when a particular seasonal habitat type is limiting GRSG populations.

Meadows are considered a limited resource throughout the sagebrush ecosystem landscape in Nevada; however, meadow ecosystems are disproportionately important for GRSG to fulfill their late brood-rearing life cycle requirements. The absence of crucial meadows can render an area unsuitable for GRSG, even if other seasonal resources are present. Due to their limited area in comparison to uplands, meadow ecosystems could result in relatively smaller functional acre scores in the HQT despite their importance. To more accurately reflect the value of meadows to GRSG, a mitigation ratio is applied to each map unit designated as meadow in the HQT (see the *CCS Manual* for more information). Map units designated as meadows should be prioritized for conservation efforts.

#### EXAMPLE MAP UNIT CALCULATION (LANDSCAPE SCALE)

Map Unit 1 is located within a Priority Habitat Management area as defined by the Sagebrush Ecosystem Program's Management Categories ma. In addition, Map Unit 1 is not designated as a meadow system. These landscape-scale parameters are depicted in the table below. Blank cells will be filled in as examples are discussed throughout the document.

Table 2. Example map unit calculation (landscape scale)

	Management Category	Meadow System	Local-Scale Function	Site-Scale Function	Overall Function	Acres	Functional Acres
<b>Breeding</b>	PHMA	No Meadow				18	
<b>LBR</b>	PHMA	No Meadow				18	
<b>Winter</b>	PHMA	No Meadow				18	

### 3.2.3 PINYON-JUNIPER REMOVAL

Pinyon and juniper trees have encroached upon the sagebrush steppe in the Intermountain Region in recent history and can have significant effects on GRSG even when pinyon-juniper (P/J) cover is sparse (Coates et al. 2017). Effects of P/J (and its removal) on GRSG have been assessed in several studies that found decreased probability of nest success with increasing P/J cover class (Sandford et al. 2017), increased nest survival (19%) following Phase I conifer removal (Severson et al. 2017), and greater benefits to GRSG when P/J removal was conducted near lek sites (Farzan et al. 2015). P/J removal reduces the number of predator perches and perceived threats, increases forage, and increases connectivity to mesic areas, all which enhance overall GRSG habitat quality (Sandford et al. 2017).

Sagebrush communities experiencing Phase I P/J encroachment are still used by GRSG, but with a greater risk of predation; however, Phase II P/J is generally avoided (Coates et al. 2017). This suggests that when Phase II conifer is removed from an otherwise intact sagebrush system previously inaccessible GRSG habitat can be reclaimed, and the conversion of Phase II into Phase III woodland can be halted. The nearly irreversible conversion of lost GRSG habitat from Phase I to Phase III woodland occurs at a rate of more than 100,000 acres per year in the Great Basin (Miller et al. 2008).

Removal of pinyon-juniper encroachment in otherwise intact GRSG habitat is a tremendous opportunity to benefit GRSG and other sagebrush-obligate species. Where P/J removal is likely to benefit GRSG within a project area, the Credit System recognizes the importance of its completion. In these situations, P/J removal factors for map units defined as Phase I (1 - 10% canopy cover) or Phase II P/J (> 10% canopy cover) will be applied to the local scale GRSG habitat function. This will determine the uplift credits that will become available upon completion of P/J removal. See the *CCS Manual* for more information.

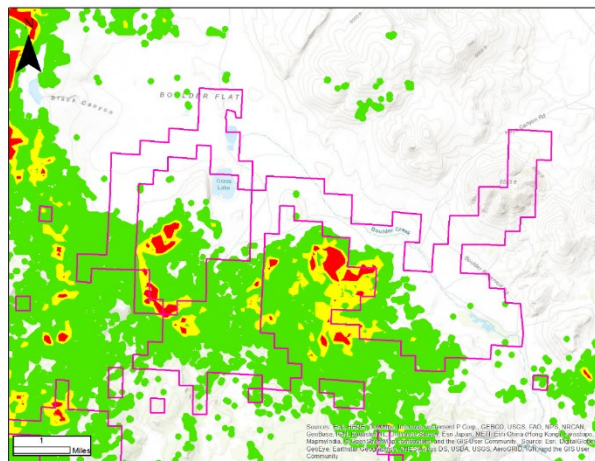

Figure 7. Example SEP map used to provide initial determination of areas of pinyon-juniper cover

### 3.3 LOCAL SCALE (3<sup>RD</sup> ORDER)

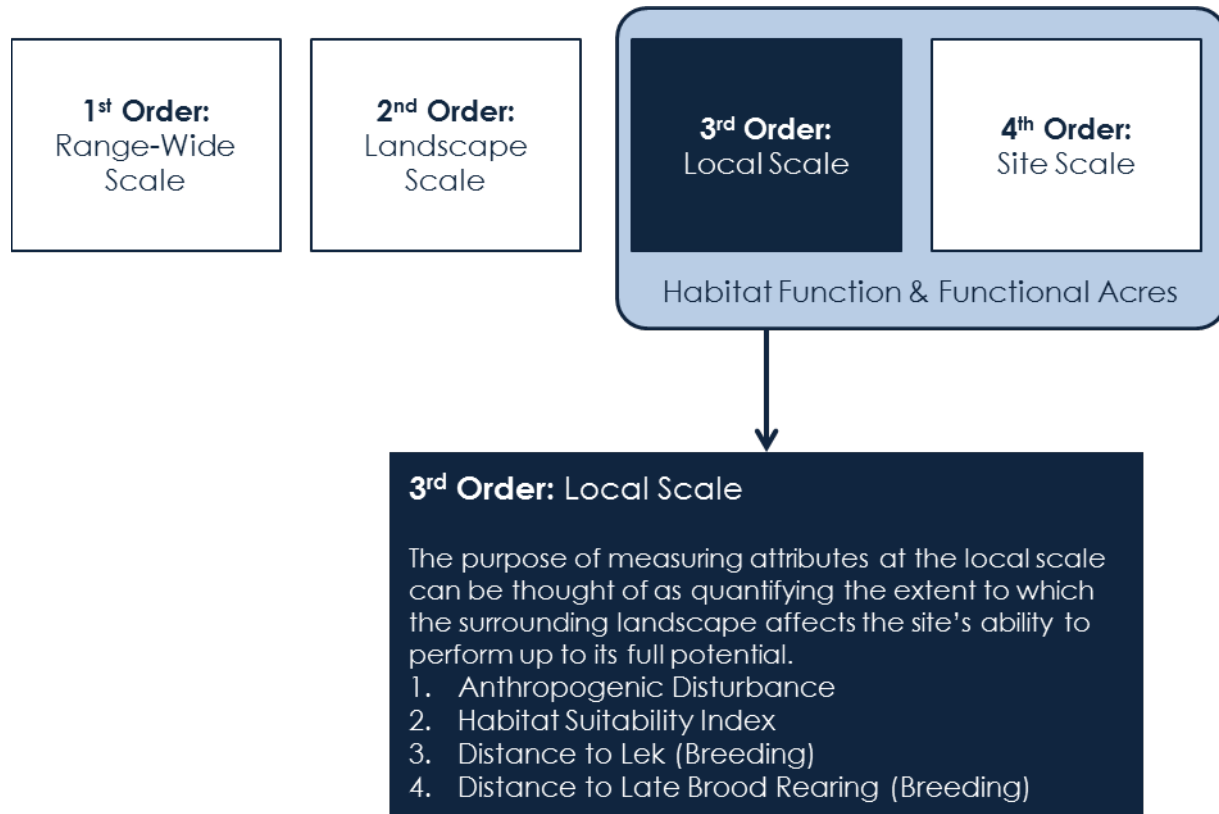

Figure 8. Third order use of multiple spatial scales for quantifying GRSG habitat function

The significance of the effect of local conditions on the quality of any given area is an important consideration (Knick and Connelly 2011, Connelly et al. 2011). GRSG habitat conditions within and surrounding a project site may affect GRSG seasonal habitat use, dispersal, local persistence, and overall population trend (Connelly et al. 2011). The HQT assesses GRSG habitat function at the local scale related to anthropogenic disturbance, suitability as identified by the Habitat Suitability Index (HSI) and, for breeding habitat function, Abundance and Space Use Index Score (ASUI), and distance to nearest late brood-rearing habitat.

The significance of the effect of local conditions on the quality of any given area is an important consideration (Knick and Connelly 2011, Stiver et al. 2015). GRSG habitat conditions within and surrounding a project site may affect GRSG seasonal habitat use, dispersal, local persistence, and overall population trend (Knick and Connelly 2011, Connelly et al. 2011). The HQT assesses GRSG habitat function at the local scale related to anthropogenic disturbance, suitability as identified by the Habitat Suitability Index (HSI) and, for breeding habitat function, Abundance and Space Use Index Score (ASUI), and distance to nearest late brood-rearing habitat.

#### 3.3.1 ANTHROPOGENIC DISTURBANCE

Indirect effects of anthropogenic disturbance are measured by applying scientifically informed distance-decay curves to GRSG habitat around anthropogenic features. The cumulative aspect of the distance-decay curves accounts for the density effects of anthropogenic disturbance on GRSG habitat function (Harju et al. 2010, Connelly et al. 2011). For each anthropogenic disturbance considered, both a distance over which the effect of the disturbance extends, and a relative weight are assigned. Effects of distance from anthropogenic disturbances are generally well established (Manier 2014) and are based on available literature and expert opinion (see [Appendix 4](#) for a review of literature pertaining to the effects of anthropogenic disturbance on GRSG). Weights represent the relative degree of disturbance, relative to the highest level of disturbance possible, and are based on literature and expert opinion. The magnitude of the effect at specific distances for anthropogenic disturbances is represented by an exponential decay curve, which associates the most significant impact close to the source and reflects a rapid decline in impact as distance from the edge of the anthropogenic source increases. Scientific literature reports GRSG population response (e.g., lek attendance, nest selection) to anthropogenic disturbances (Holloran et al. 2010, LeBeau 2012, Blickley et al. 2012) as well as raven population response to transmission lines (Coates et al. 2014) is exponential in nature. The indirect effect relationship is established by a curve with the y-intercept the weight and the x-intercept the distance. Example distance-decay curves are provided in Figure 9.

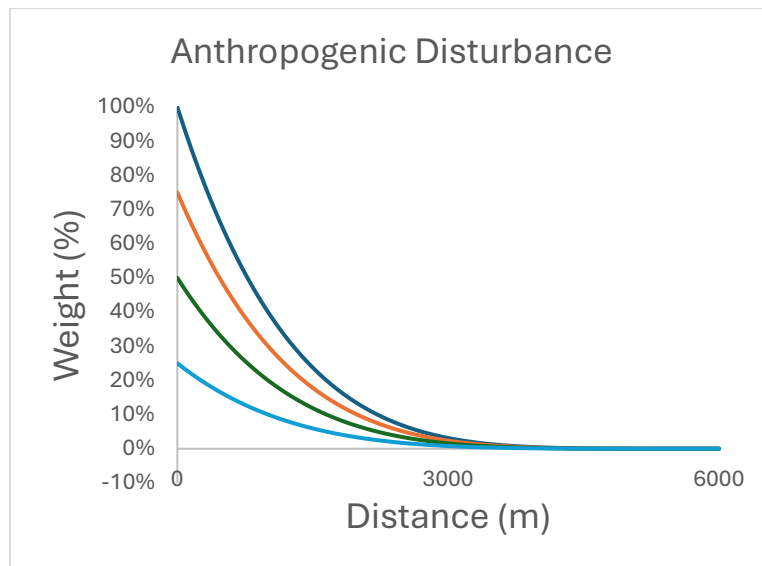

Figure 9. Example distance-decay curves with the y-intercept the weight and the x-intercept the distance associated with the anthropogenic disturbances

### SITE-SPECIFIC CONSULTATION-BASED DESIGN FEATURES

Site-specific consultation-based design features (design features) are used to minimize impacts to GRSG and its habitat from indirect effects of anthropogenic disturbance. When quantifying the indirect effect of anthropogenic disturbance on GRSG habitat function (e.g., for a debit project), the use of design features may minimize the indirect effects of certain anthropogenic disturbances or minimize the indirect effects during certain times of the year. Distance-decay curves applied to habitats around the anthropogenic disturbance may be modified to more accurately reflect minimization of disturbances. See [Appendix 1](#) in the 2019 Nevada Greater Sage-grouse Conservation Plan for more information on the use of design features for newly proposed projects and modifications to existing projects.

Anthropogenic features considered by the Credit System, and their assigned weights and distances, are described in Table 3.

Table 3. Anthropogenic features considered by the credit system with assigned weights and distances

<b>TYPE</b>	<b>SUBTYPE</b>	<b>TYPE CODE<sup>1,2</sup></b>	<b>SUBTYPE CODE<sup>1,2</sup></b>	<b>WEIGHT (%)</b>	<b>DISTANCE (Meters)</b>
<b>Towers</b>	Communications <sup>1</sup>	<b>Towers</b>	<b>Communications</b>	75%	6,000 m
	Meteorological	<b>Towers</b>	<b>Meteorological</b>	75%	6,000 m
<b>Powerlines<sup>2</sup></b>	Nest Facilitating	<b>Powerlines</b>	<b>Nest_Facilitating</b>	75%	6,000 m
	Non-Nest Facilitating	<b>Powerlines</b>	<b>Non_Nest_Facilitating</b>	25%	6,000 m
<b>Mines</b>	Active – Large	<b>Mines</b>	<b>Active_Large</b>	100%	6,000 m
	Active – Med or Small	<b>Mines</b>	<b>Active_Small</b>	100%	3,000 m
	Inactive – Large	<b>Mines</b>	<b>Inactive_Large</b>	50%	1,000 m
	Inactive – Med or Small	<b>Mines</b>	<b>Inactive_Small</b>	10%	1,000 m
	Ancillary – Large	<b>Mines</b>	<b>Active_Large_Ancillary</b>	50%	3,000 m
	Ancillary – Med or Small	<b>Mines</b>	<b>Active_Small_Ancillary</b>	50%	1,500 m
<b>Oil &amp; Gas Wells</b>	Producing	<b>Oil_Gas</b>	<b>Producing</b>	100%	3,000 m
	Inactive	<b>Oil_Gas</b>	<b>Inactive</b>	0%	0 m
<b>Urban, Suburban, Ex-Urban Development<sup>3</sup></b>	Med – High	<b>Urban</b>	<b>High</b>	100%	6,000 m
	Low	<b>Urban</b>	<b>Low</b>	75%	3,000 m
<b>Roads</b>	Interstate	<b>Roads</b>	<b>Interstate</b>	100%	6,000 m
	High Use – Paved or Improved; Commercial	<b>Roads</b>	<b>High_Use</b>	100%	3,000 m
	Low Use – Improved; Local	<b>Roads</b>	<b>Low_Use</b>	25%	1,000 m
<b>Railways</b>	Railways	<b>Railway</b>	<b>Railway</b>	100%	3,000 m
<b>Renewable</b>	Geothermal	<b>Renewable</b>	<b>Geothermal</b>	100%	6,000 m
	Ancillary – Geothermal	<b>Renewable</b>	<b>Geothermal_Ancillary</b>	50%	3,000 m
	Solar	<b>Renewable</b>	<b>Solar</b>	25%	1,000 m
	Wind	<b>Renewable</b>	<b>Wind</b>	25%	6,000 m

<b>Linear Rights of Way</b>	LROW – High	<b>LROW</b>	<b>LROW_High</b>	50%	1,000 m
	LROW – Low	<b>LROW</b>	<b>LROW_Low</b>	25%	500 m
<b>Mineral Exploration<sup>4</sup></b>	Mineral Exploration	<b>Exploration</b>	<b>Exploration</b>	100%	0 m
<b>Other Disturbance</b>	Other -High <sup>5</sup>	<b>Other</b>	<b>Other_High</b>	75%	6,000 m
	Other – Medium <sup>6</sup>	<b>Other</b>	<b>Other_Medium</b>	50%	3,000 m
	Other – Low <sup>7</sup>	<b>Other</b>	<b>Other_Low</b>	25%	1,000 m
	No Indirect Disturbance	<b>Other</b>	<b>No_Indirect_Dist</b>	100%	0 m

<sup>1</sup>This category includes satellites, large telescopes, and other antennas for communication or broadcasting.

<sup>2</sup>The project proponent may request to review and adjust the weight and distance criteria based upon powerline height, construction, perch deterrents or other site-specific factors. Any requests must be submitted to the Administrator and approved by the Scientific Committee.

<sup>3</sup>The Urban Low classification includes landfills.

<sup>4</sup>Mineral exploration is a special case of impact type and includes exploration associated with CCS defined disturbance within Table 3, including mining, oil and gas, geothermal, etc. Additional information is provided throughout this guide for this type of impact.

<sup>5</sup> Examples include: Structures that could be used as perching and nesting by ravens; consistent or continuous noise; subsidies that would act as predator attractants; continuous activity and other attributes that suggest large-scale disturbance. The SETT intends to capture the majority of disturbances within the provided weights and distances. If warranted, the SETT may determine the 75% weight for the High category be adjusted to 100% under certain circumstances. The SETT would bring any proposed disturbances that may warrant a 100% weight to the SEC for consideration.

<sup>6</sup>Examples include: Disturbances that are minimized using measurable methodologies; intermittent or less continuous noise and activity.

<sup>7</sup>Examples include: Disturbances that do not exhibit significant indirect impacts; general presence of infrastructure, direct habitat loss, and potential for invasive weed spread from ground disturbance will be the primary impacts expected.

<sup>8</sup>When digitizing anthropogenic features or categorizing proposed surface disturbance, the Type and Subtype attributes must be exactly the same as the Type and Subtype codes provided in this table, including capitalization. To aid in digitization, editing templates have been provided.

<sup>12</sup>All above-ground facilities associated with the anthropogenic feature are classified as the type and subtype of the feature it is associated with. Substations that are associated with a LROW feature should be classified according to the height and width criteria that classifies whether a feature falls within a Low or High LROW.

**CALCULATION METHOD**

1. To calculate anthropogenic disturbance, anthropogenic features are digitized within a GIS.
2. Distance to the nearest anthropogenic feature for each disturbance subtype is calculated to create a continuous surface raster representing the distance from each cell to the nearest feature.
3. For each raster, distances are translated into functional scores using inverted distance-decay curves (i.e., 80% weight on the distance-decay curve represents a 20% function score).
4. Each raster is multiplied together to produce a final raster, where values range from 0 (full impact) to 1 (no impact). Figure 10 depicts the indirect effects of anthropogenic disturbance on GRS habitat in the form of a continuous surface raster.

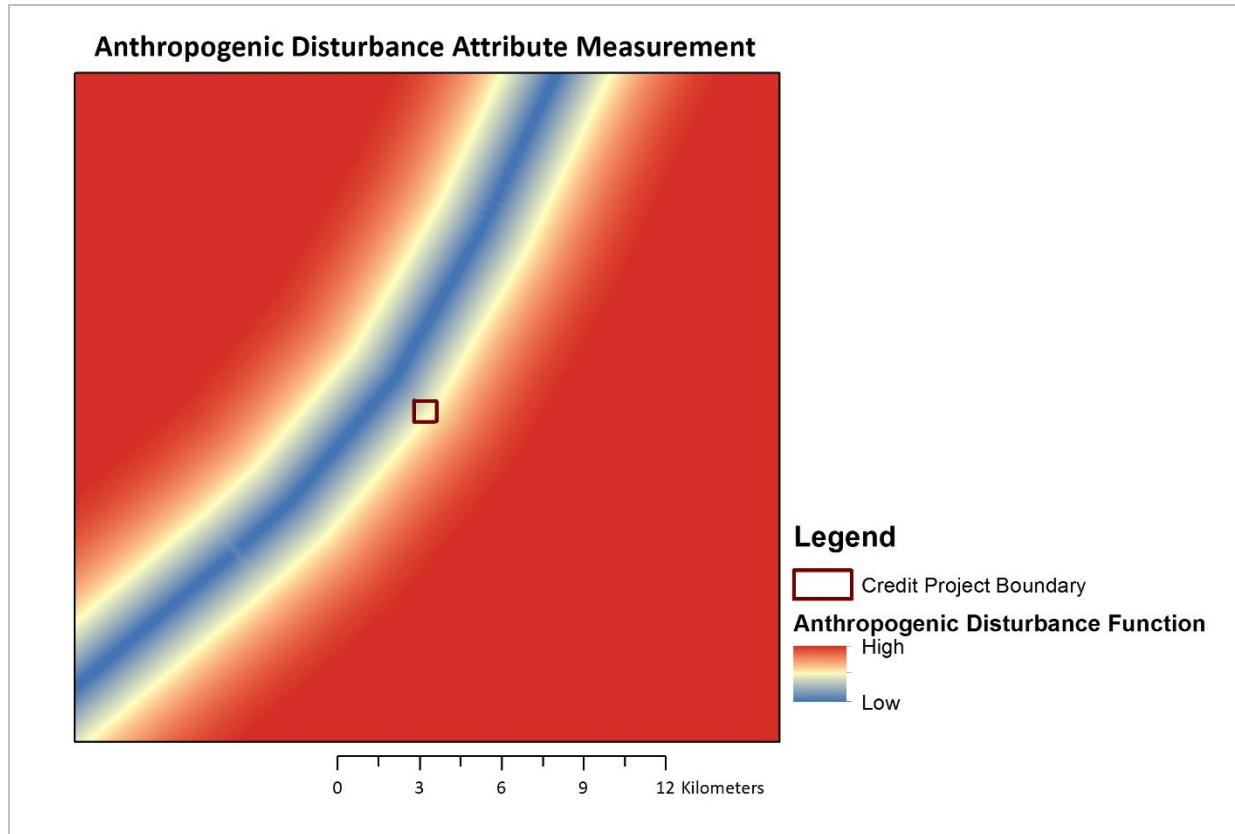

Figure 10. Habitat function due to the indirect effects of anthropogenic disturbance on GRSG habitat in the area surrounding an example credit project site

### 3.3.2 HABITAT SUITABILITY INDEX

The Habitat Suitability Index (HSI) is used as a local-scale modifier of habitat function. The HSI was generated based on model-averaged resource selection functions informed by more than 31,000 independent telemetry locations from more than 1,500 radio-marked GRSG across 12 project areas in Nevada and northeastern California collected during a 15-year period (1998 – 2013). Modeled habitat covariates included land cover composition, water resources, habitat configuration, elevation, and topography, each at multiple spatial scales that were relevant to empirically observed GRSG movement patterns (Coates et al. 2014). The HSI is also used in the Sagebrush Ecosystem Program's Management Categories map, which determines management importance (see [Section 3.2.1 Management Category Importance](#)). However, the Management Categories value space use (i.e., modelled probability of GRSG occupancy) more highly than habitat suitability, and classifies the HSI into broad categories (high, moderate, low and non-habitat), whereas the HSI is used at the local scale at far higher resolution to evaluate habitats based on local context.

Four HSI maps were modeled to represent annual and seasonal (e.g. spring, summer, winter) habitat use of GRSG (Coates et al. 2020), which provided an updated product to the original 2014 HSI. The original HSI values for each season are used as the scoring curve to assign habitat function, and no scaling or reclassification is applied to the seasonal HSI values. Each map unit within a credit or debit project is evaluated based on the averaged HSI scores for each season and the highest scoring seasonal habitat is used as the local-scale modifier when calculating habitat function.

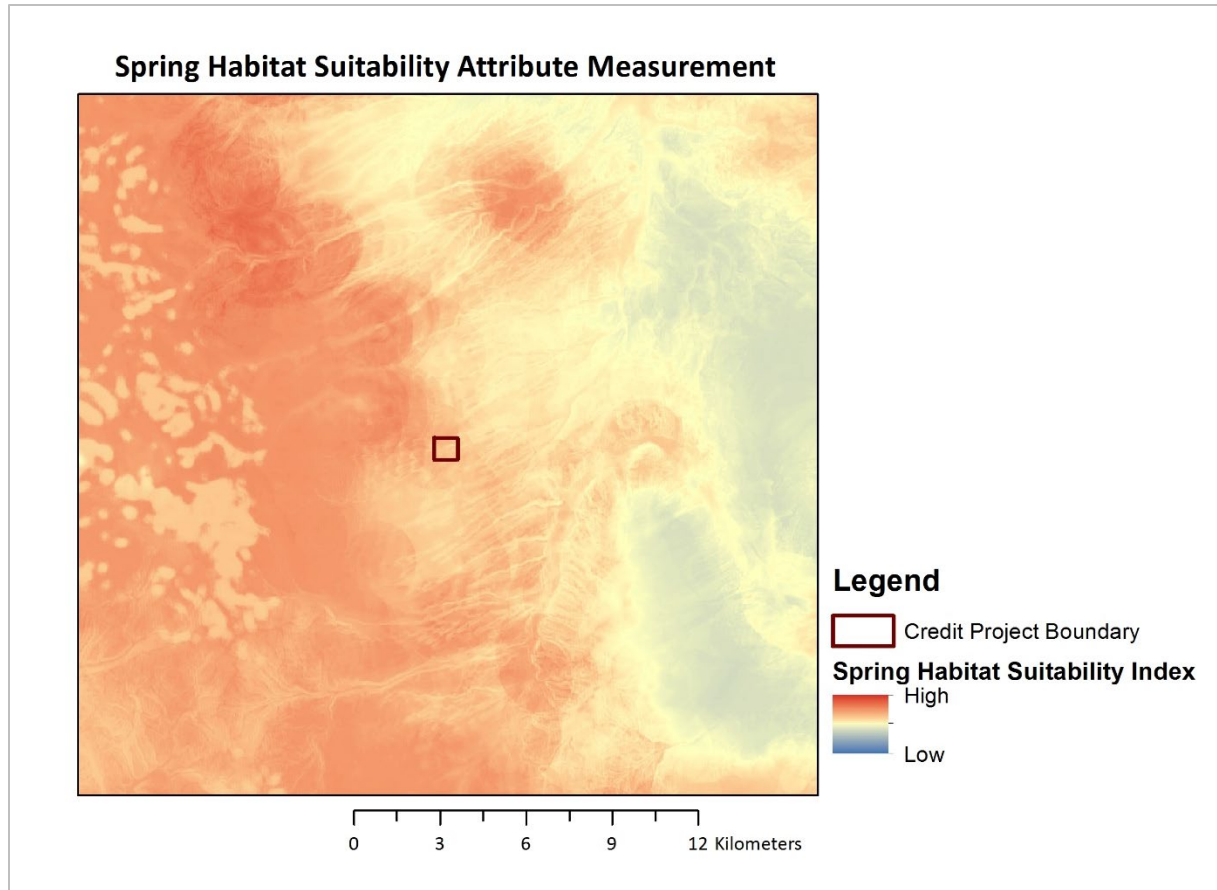

Figure 11. Habitat suitability related to the Spring HSI in the area surrounding an example credit project site

### 3.3.3 ABUNDANCE & SPACE USE INDEX SCORE (ASUI)

GRSG breeding habitat quality is influenced by several factors, including proximity to lek locations and GRSG abundance (peak-male attendance, Milligan et al. 2024). The majority of females that breed on a given lek will nest within 3.73 miles (6 kilometers) of that lek (Colorado Division of Wildlife et al. 2008); however, some females will nest beyond 3.73 miles (6 kilometers) from the lek they breed upon (Doherty et al. 2010, Holloran et al. 2010). To account for this, the HQT will assign different scores to areas depending on how far away from a lek they occur (Figure 12).

The abundance and space use index (ASUI) layer improves upon the `dist_lek` layer in the most recent version of the HQT by incorporating peak-male lek attendance in combination with distance to nearest lek (Milligan et al. 2024). In addition to assigning scores based on an area's proximity to the nearest lek, the HQT will also assign a higher relative score to areas near leks receiving greater peak-male attendance (Figure 13). The ASUI score is multiplied by all other local-scale attribute scores to calculate overall local-scale function for breeding habitat (Figure 16).

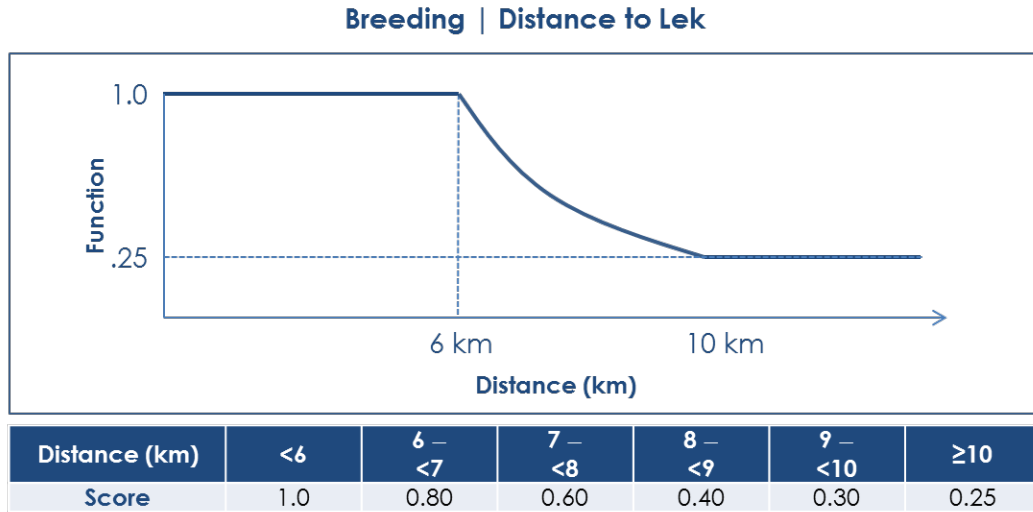

Figure 12. Scoring curve and table for distance to lek attribute as modifier to breeding habitat function

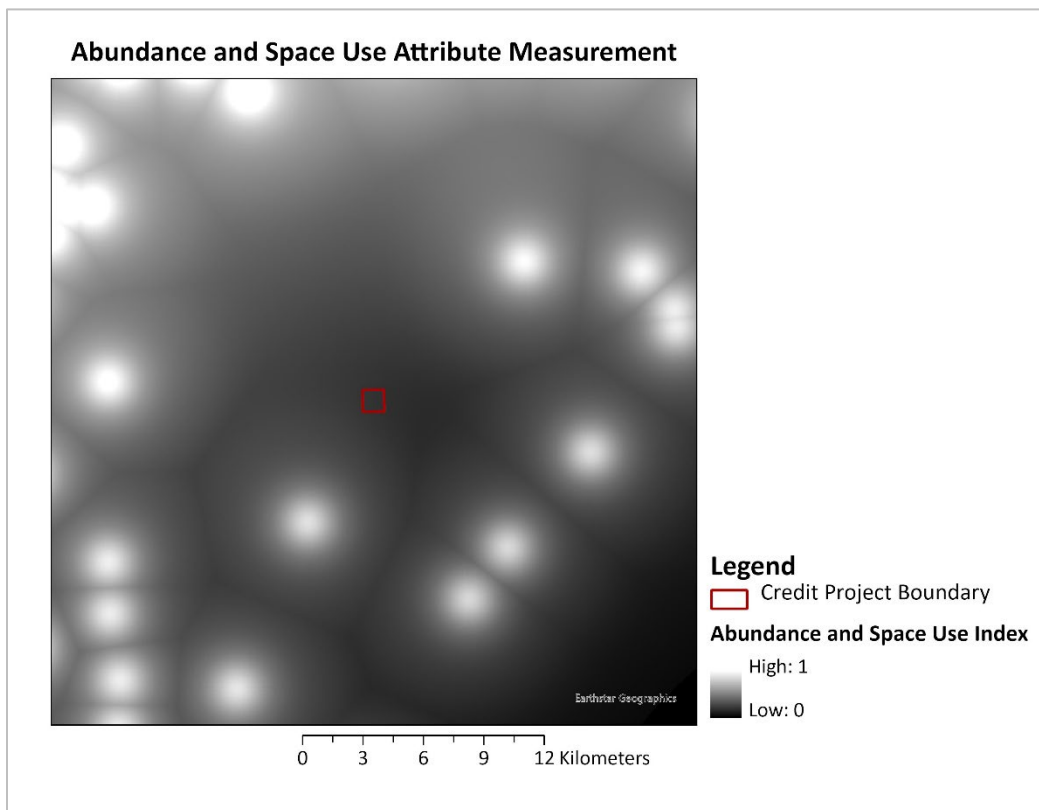

Figure 13. Effect of abundance and space use on breeding habitat function for an example credit project

### 3.3.4 DISTANCE TO LATE BROOD-REARING HABITAT

Research indicates chick survival drops significantly when broods are required to travel greater than 1.86 miles (3 kilometers; (Gibson et al. 2013)). However, some broods successfully travel long distances to late brood-rearing habitat. Therefore, distance to late-brood rearing habitat is a modifier of breeding habitat

function as follows: map units within 1.86 miles (3 kilometers) of late brood-rearing habitat receive a score of 1.0 followed by a decline between 1.86 and 3.73 miles (3 and 6 kilometers) from late brood-rearing habitat, map units farther than 3.73 miles (6 kilometers) from late brood-rearing habitat receive a score of 0.25 (Figure 14). The distance to late brood-rearing score is multiplied by all other local-scale attribute scores to calculate overall local-scale habitat function for breeding habitat.

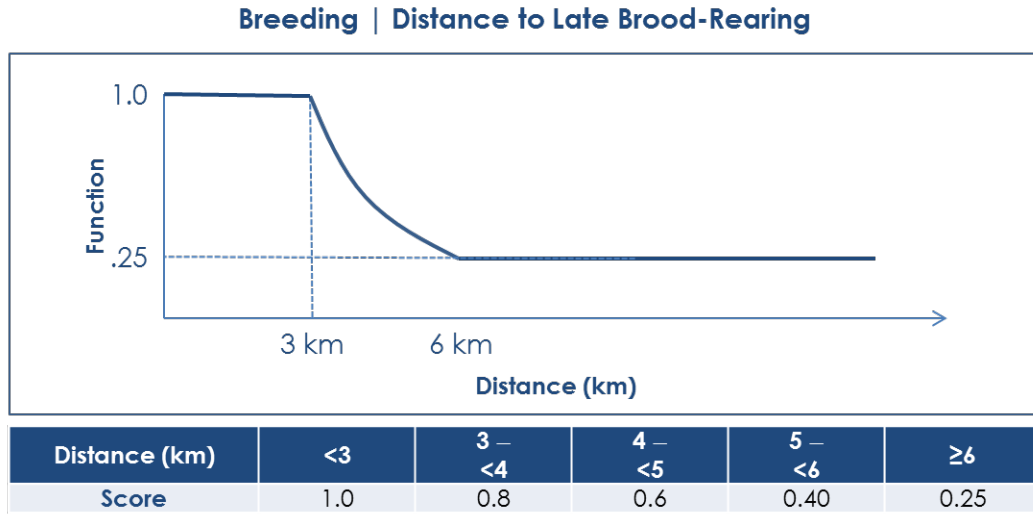

Figure 14. Scoring curve and table for distance to late brood-rearing habitat attribute as modifier to breeding habitat function

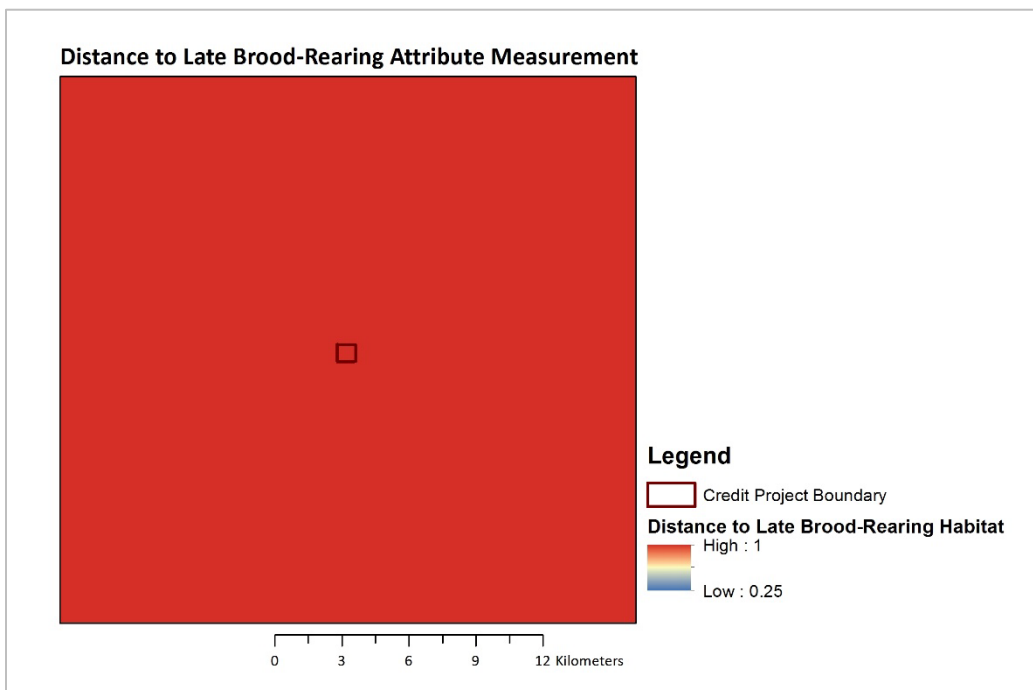

Figure 15. Effect of distance to late brood-rearing habitat on breeding habitat function for an example credit project

### EXAMPLE MAP UNIT CALCULATION (LOCAL SCALE)

Each local-scale attribute is measured either through direct digitization of high-resolution aerial imagery or with geospatial layers in a GIS. Local-scale function is calculated separately for each seasonal GRSG habitat type: breeding, late brood-rearing, and winter (Figure 16). Local-scale function is measured to be 38% for breeding, 36% for late brood-rearing and 28% winter seasonal habitats for Map Unit 1.

Table 4. Example map unit calculation (local scale)

	Management Category	Meadow System	3 <sup>rd</sup> Order Function	4 <sup>th</sup> Order Function	Overall Function	Acres	Functional Acres
<b>Breeding</b>	PHMA	No Meadow	38%			18	
<b>LBR</b>	PHMA	No Meadow	36%			18	
<b>Winter</b>	PHMA	No Meadow	28%			18	

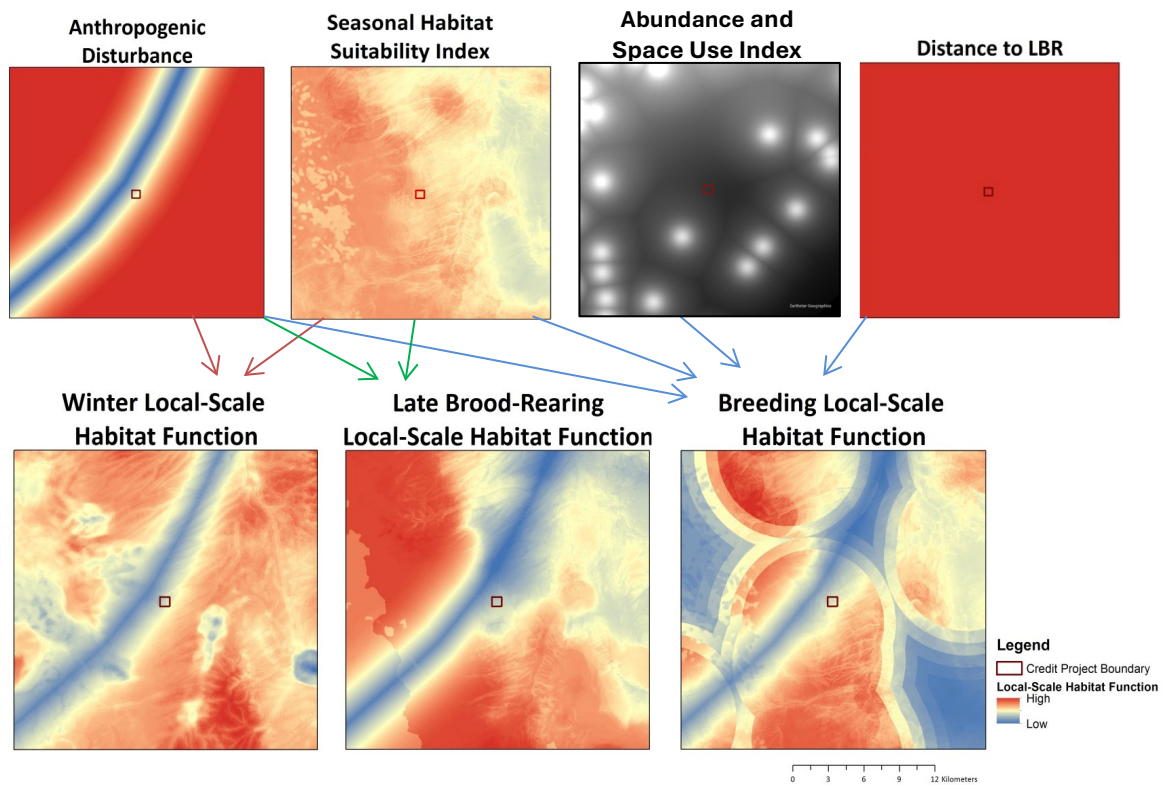

Figure 16. Local-scale attributes are measured in a GIS and combined to calculate local-scale habitat function for each seasonal sage-grouse habitat type

### 3.4 SITE SCALE (4<sup>TH</sup> ORDER)

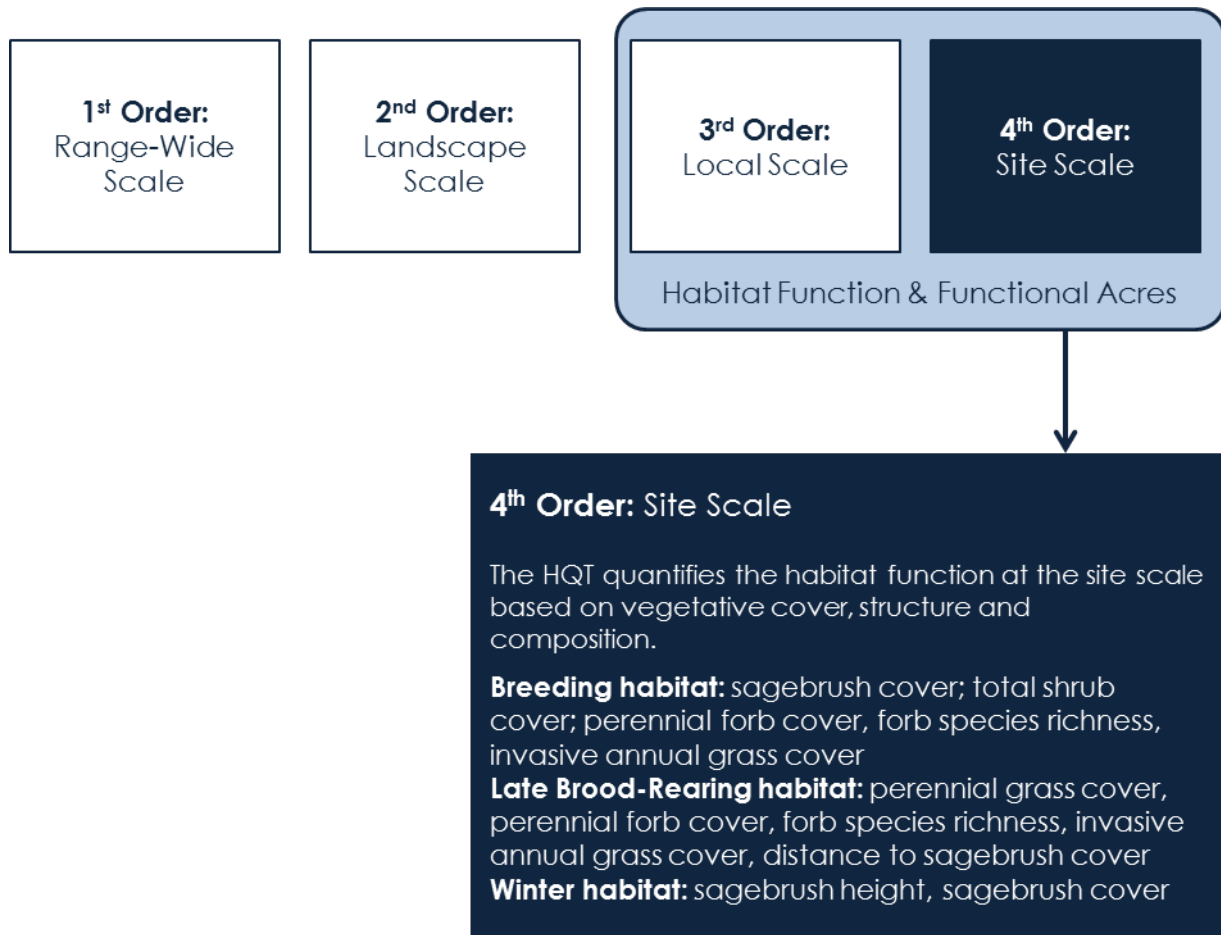

Figure 17. Fourth order use of multiple spatial scales for quantifying GRSG habitat function

The HQT quantifies GRSG habitat function at the site scale based on vegetative cover, structure, and composition. Measurements include attributes that are indicative of an area's suitability and quality for GRSG, including conditions that support breeding, late brood-rearing, and winter habitats. Vegetation attributes are measured within each map unit and scored based on triggers, scoring curves and tables, and weighting. Modifiers of site-scale function, including invasive annual grass and distance to sagebrush, are applied to GRSG habitat function for the appropriate seasonal habitat types.

The concept model below illustrates the conditions being measured at the site scale and the role they play in providing suitable breeding, late brood-rearing, and winter habitat (Figure 18).

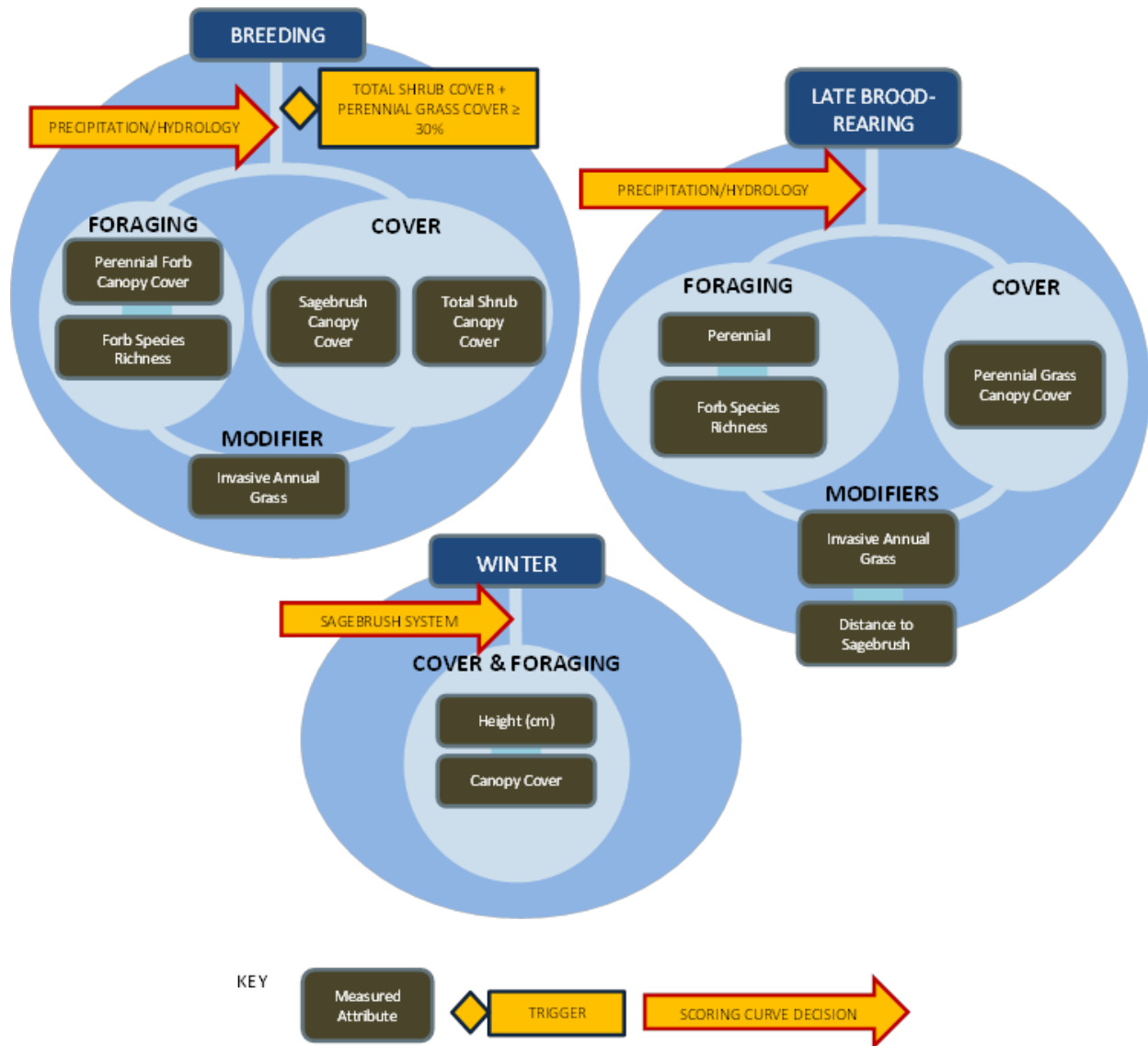

Figure 18. Conceptual model depicting GRS life history requirements at the site scale (4th order)

---

### 3.4.1 TRIGGERS

---

For breeding habitat, when sagebrush cover is less than 25%, there should be at least 10% perennial grass cover (Coates and Delehanty 2010, Coates et al. 2011). However, the relationship is dynamic—as cover of sagebrush increases, perennial grass cover becomes less important. Further, any type of shrub can be used for cover. Therefore, a combined cover of 30% for total shrub cover and perennial grass cover is required for the map unit to be scored for breeding habitat function. Combined total shrub cover and perennial grass cover is a trigger to indicate that a map unit contains functional breeding habitat. If the trigger is met, the map unit is scored as usual for breeding habitat. If the trigger is not met, the map unit receives a breeding habitat score of zero. The map unit may still receive a score for other seasonal GRSG habitat types.

---

### 3.4.2 SCORING CURVES

---

A set of scoring curves has been developed by the TRG for each attribute measured to reflect an attribute's potential for supporting GRSG for a given measurement of that attribute, representing how a site's GRSG habitat function changes as the attribute measurements change. The scoring curves for all of the vegetation attributes measured are included in [Appendix 1](#). Scoring curves are used to score average measurements for each attribute within a map unit. Separate scoring curves are used for some attributes based on the map unit's mean annual precipitation, hydrologic system, and dominant sagebrush community.

#### PRECIPITATION REGIME & HYDROLOGIC SYSTEM

The wide geographic range of GRSG results in different vegetation potentials in different regions in Nevada. This may be due to variation in factors such as mean annual precipitation and the site's hydrology. Encouraging the identification of suitable areas and high-quality GRSG habitat within each region of the state requires some flexibility in how attributes are scored. For example, vegetation height in lower precipitation areas may not attain the same levels as vegetation in wetter areas, even though the former area may otherwise be high quality GRSG habitat.

The HQT addresses this potential for variability by using different scoring curves for sites in arid-shrub conditions, mesic-shrub conditions, and meadow systems.

**Arid-shrub condition:** sites with mean annual precipitation of less than 10 inches (25.4 centimeters)

**Mesic-shrub condition:** sites with mean annual precipitation of greater than or equal to 10 inches (25.4 centimeters)

Note that annual precipitation changes (e.g., drought conditions) are different than mean annual precipitation as used by the HQT. Refer to PRISM Climate Group's "30-yr Normal Precipitation: Annual" for annual precipitation zones at <http://prism.oregonstate.edu/normal/>.

#### DOMINANT SAGEBRUSH COMMUNITY

Different scoring curves for winter habitat function are used based on the dominant sagebrush community present. Sites dominated by Wyoming big sagebrush or mountain big sagebrush (*Artemisia tridentata* ssp.), which are typically taller and found where snow is deeper, are scored with different curves than sites dominated by low sagebrush (*Artemisia arbuscula* ssp.) or black sagebrush (*Artemisia nova*), which are typically shorter and found in areas where snow dissipates more quickly due to wind and solar radiation.

#### APPLICATION OF SCORING CURVES

After establishing the specific seasonal GRSG habitats to be scored and which scoring curves to use, the average measurement for each vegetation attribute in the map unit is scored using the appropriate scoring curve. For example, Figure 19 is the scoring curve and associated table for sagebrush canopy cover for scoring breeding habitat function.

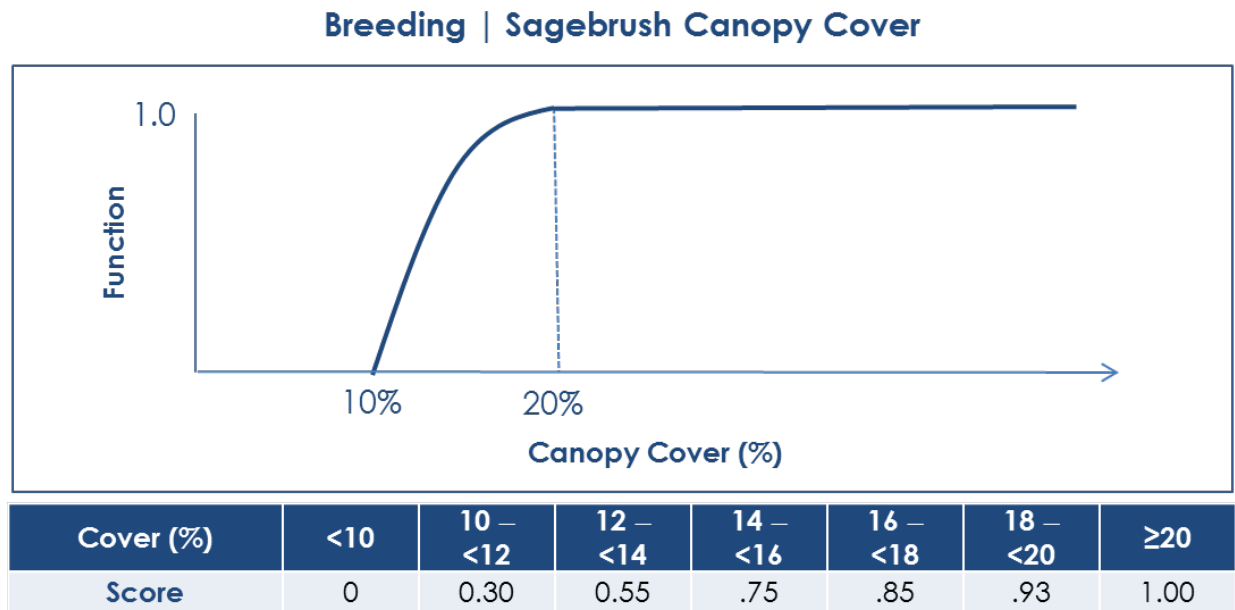

Figure 19. Scoring curve and table for sagebrush canopy cover in breeding habitat

The scoring curve above establishes the relationship between sagebrush canopy cover and breeding habitat function, the shape of which is established from literature and expert opinion. The scoring curve establishes the GRSG habitat function of each site relative to fully-functioning conditions—from 0 (non-functioning) to 1.0 (fully-functioning canopy cover).

### 3.4.3 ATTRIBUTE WEIGHTING

The score for each attribute is then weighted as established in

Table 5. Description of vegetation attributes measured and attribute weight. The weights are based on expert opinion, are on a relative scale and add to 100%. See also Connelly et al. (2011) for a review of requirements for GRSG habitat, and aforementioned literature citations (and the citations within) that describe GRSG habitat. The scores are multiplied by the weight, and the weighted scores across all attributes for that season are then added to generate a score for a map unit.

### 3.4.4 ATTRIBUTES MEASURED

The following attributes of site vegetation are measured (the following tables are adapted from Table 4-1 in *Appendix B* “Development Process and Justification for Habitat Objectives for Greater Sage-grouse in Nevada” in the Nevada State Plan). Attributes must be measured for each seasonal GRSG habitat type during the appropriate time of year, except for winter habitat attributes which can be measured at any time.

Table 5. Description of vegetation attributes measured and attribute weight

<b>BREEDING</b>			
<b>(SAMPLE WINDOW APRIL 15 THROUGH JUNE 15)</b>			
Category	Attribute	Description	Weight
Cover	Sagebrush canopy cover	This serves as nesting horizontal overstory substrate. The presence of sagebrush in nesting habitat is an active variable in all studies of GRSG (Connelly et al. 2000, Kolada et al. 2009b, 2009a, Blomberg et al. 2012). Qualifying sagebrush species are defined in the Credit System User's Guide. This is estimated with line intercept.	20%
	Total shrub canopy cover (includes sagebrush)	Shrub species such as rabbitbrush ( <i>Chrysothamnus spp.</i> ), antelope bitterbrush ( <i>Purshia tridentata</i> ), and horsebrush ( <i>Tetradymia canescans</i> ) are associated with higher nest success. Where sagebrush canopy cover is high, other brush species play a positive role. Total canopy cover of all species is a positive attribute for nest success (Kolada et al. 2009b, Coates and Delehanty 2010). This is estimated with line intercept.	30%
Foraging	Perennial forb canopy cover	Forbs are an important food resource and are a primary GRSG habitat component affecting brood persistence (Casazza et al. 2011). This is estimated along line transects within Daubenmire frames.	25%
	Forb species richness	This is a measure of the number of forb species (excluding noxious weeds as designated in NAC 555.010), both perennial and annual, available across the early brood-rearing period. Data indicate there is a direct correlation between the number of forb species present and GRSG persistence (Casazza et al. 2011). Species are tallied within Daubenmire frames along line-transects.	25%
Trigger	Perennial grass canopy cover	Combined perennial grass canopy cover and total shrub canopy cover must exceed 30% to be scored for breeding.	N/A

**LATE BROOD-REARING**  
**SAMPLE WINDOW APRIL 15 THROUGH JUNE 15**

Category	Attribute	Description	Weight
Cover	Perennial grass canopy cover	Perennial grass cover is higher (17.4% versus 12%) in selected sites than non-selected sites (Kirol 2012). This is estimated along line transects within Daubenmire frames.	25%
Foraging	Perennial forb canopy cover	Forbs are an important food resource and are a primary GRSG habitat component affecting brood persistence (Casazza et al. 2011). This is estimated along line transects within Daubenmire frames.	37.5%
	Forb species richness	This is a measure of the number of forb species (excluding noxious weeds as designated in NAC 555.010), both perennial and annual, available across the late brood-rearing period. Data indicate there is a direct correlation between the number of forb species present and GRSG persistence (Casazza et al. 2011). Species are tallied within Daubenmire frames along line transects.	37.5%

**WINTER  
(SAMPLE ANYTIME)**

Category	Attribute	Description	Weight
Cover & Foraging	Shrub canopy cover	During winter, sagebrush canopy cover serves as both food and cover for GRSG (Connelly et al. 2000). This is estimated with line intercept.	50%
	Sagebrush height	Access to sagebrush during winter conditions is important (Connelly et al. 2011). This measures the average height of sagebrush. It is collected along line transects.	50%

**3.4.5 MODIFICATION OF SITE-SCALE HABITAT FUNCTION**

GRSG habitat function is modified at the site scale by invasive annual grass cover for breeding and late brood-rearing habitat function and distance to sagebrush cover for late brood-rearing habitat function. Scores associated with each modifier are multiplied by the pre-modified site-scale function of the appropriate seasonal GRSG habitat types to calculate site-scale function.

**INVASIVE ANNUAL GRASS (BREEDING & BROOD-REARING)**

Invasive annual grass cover is a modifier for breeding and late brood-rearing habitat function and is measured along line transects within Daubenmire frames. Invasive annual grass includes, but is not limited by, noxious weed grasses as designated in NAC 555.010.

**Breeding & Late Brood-Rearing | Invasive Annual Grass**

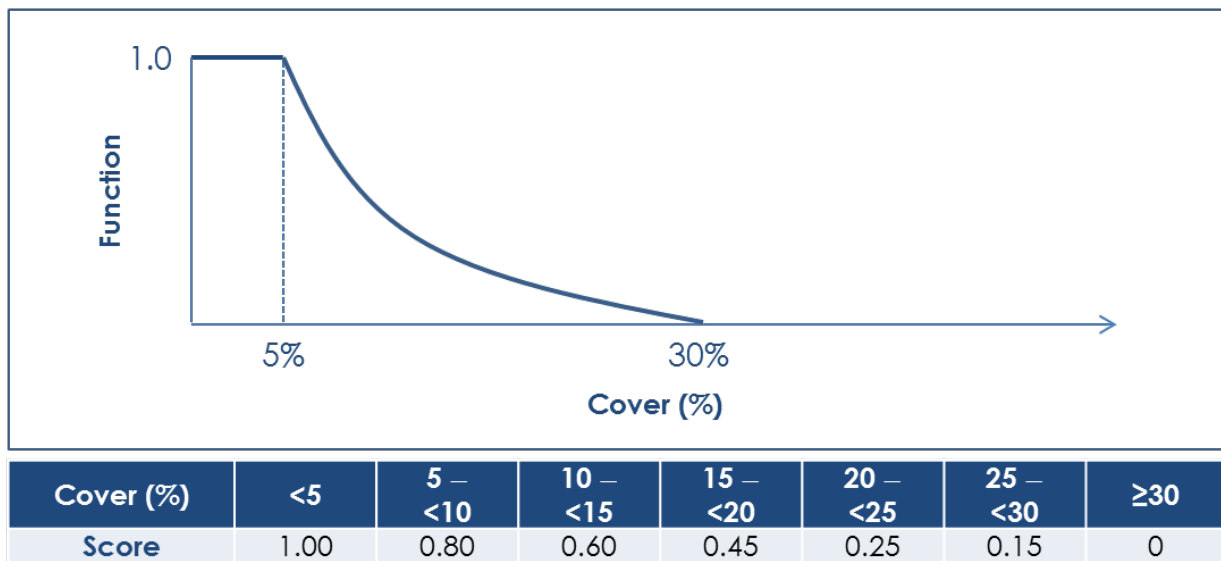

Figure 20. Scoring curve and table for invasive annual grass canopy cover as a modifier for breeding and late brood-rearing habitat

Big sagebrush communities of the Intermountain West are especially vulnerable to invasions by annual exotic grasses such as cheatgrass, which can become dominant in the herbaceous understory community (Miller et al. 2011). Invasive plants, especially invasive annual grasses (e.g., cheatgrass, and medusahead)

in sagebrush-steppe ecosystems, alter plant community structure, composition and productivity and may competitively exclude native plants important as cover and forage for GRSG (Vitousek 1990, Mooney and Cleland 2001, Rowland et al. 2010). The most pronounced negative consequence of invasive annual grass invasion into sagebrush communities is the resulting change in fire frequency and intensity (D'Antonio and Vitousek 1992, Balch et al. 2013). Ultimately, invasive annual grasses promote fires and fires promote invasive annual grasses. Fire also facilitates the conversion of rangelands from perennial-dominated to annual-dominated systems by eliminating fire-intolerant species such as big sagebrush from these systems, rendering them permanently unsuitable to GRSG (Connelly et al. 2004, Epanchin-Niell et al. 2009, Davies et al. 2011). In central Nevada, recruitment of male GRSG to leks was consistently low in areas with high proportions of exotic grasslands interspersed in the landscape within 3.11 miles (5 kilometers) of a lek, even during years when climatic conditions resulted in substantial recruitment to leks in the region (Blomberg et al. 2012).

### **DISTANCE TO SAGEBRUSH COVER (LATE BROOD-REARING)**

Late brood-rearing habitat that is classified as meadow is categorized as either unaltered or altered meadow. Unaltered meadows are defined as naturally occurring wetland complexes, dominated by wetland vegetation and soils (e.g. stringer meadows, springs, seeps) where the hydrology has been minimally altered or is currently not being managed. Altered meadows are defined as receiving either controlled irrigation, where the hydrology is currently being altered or managed (e.g. diversions, spreaders), or where the landscape is being functionally altered. Distance to sagebrush cover for altered meadow is a modifier of late brood-rearing habitat function as follows: map units within 196.9 feet (60 meter) of cover (defined as 10% cover and 11.8 inches (30 centimeters) height minimum over 98.4 feet (30 meter) x 98.4 feet (30 meter) area) of sagebrush or sagebrush mixed-shrub community (e.g., sagebrush, bitterbrush, rabbitbrush, serviceberry, broom snakeweed) receive a score of 1.0 followed by a decline between 196.8 feet (60 meter) and 984.3 feet (300 meter) to sagebrush or sagebrush mixed-shrub cover, map units farther than 984.3 feet (300 meter) from sagebrush or sagebrush mixed-shrub cover receive a score of 0.20. Distance to sagebrush or sagebrush mixed-shrub cover is measured from the 98.4 feet (30 meter) mark of every transect. Distance to sagebrush cover for unaltered meadow is a modifier of late brood-rearing habitat function that receives a score of 1.0 for any distance to sagebrush cover. The interface between the sagebrush and meadow edge is the most highly forb-productive area for GRSG and provides immediate available escape cover (Connelly et al. 2000). Based on the expert opinion of the TRG, GRSG may use specific areas (e.g., wet meadows) during the late brood-rearing season that do not have sagebrush within the perimeter of the meadow itself, as long as sagebrush is accessible to them. Scientific research also finds evidence for selection of riparian and grass cover by brood-rearing females at an 800m spatial extent (Westover et al. 2016). Meadows, riparian areas, other moist areas adjacent to sagebrush communities, and higher elevation sagebrush communities that maintain rich forb component later in summer can provide foraging areas during this season (Fischer et al. 1996a, 1996b, Connelly et al. 2000, 2011).

**Late Brood-Rearing | Distance to Late Brood-Rearing – Altered Meadow**

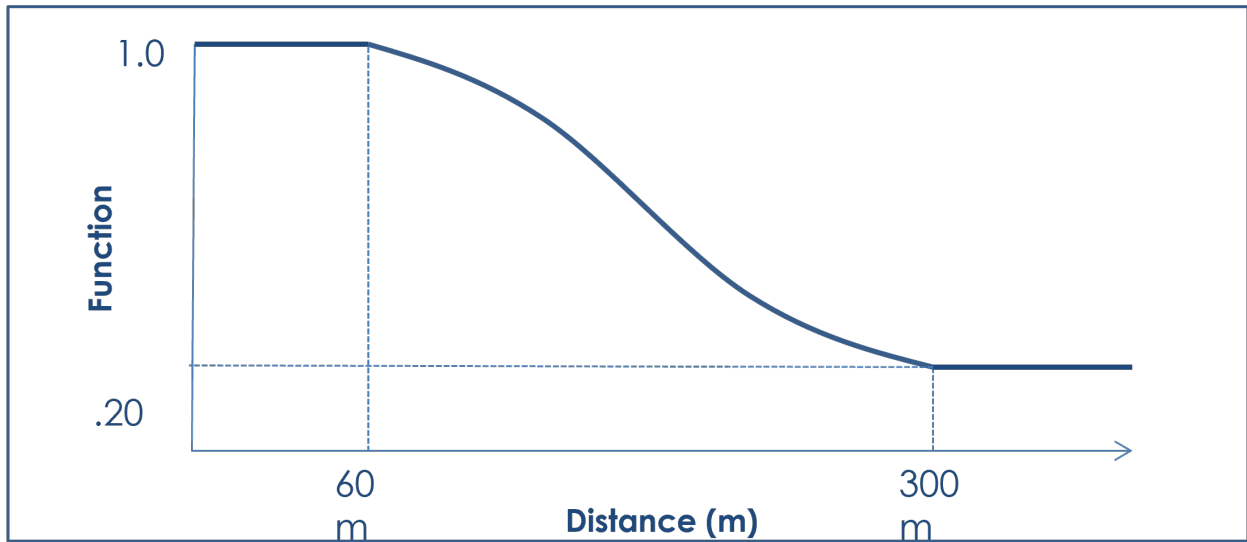

Distance (m)	<60	60 – <100	100 – <140	140 – <180	180 – <220	220 – <260	260 – <300	≥300
Score	1.00	.93	.80	.67	.54	.40	.27	.20

Figure 21. Scoring curve and table for scoring late brood-rearing habitat based on distance to sagebrush cover

**AN OPTION FOR DEBIT PROJECTS TO FOREGO ONSITE SAMPLING BY ASSUMING MAXIMUM SITE-SCALE FUNCTION**

If a Debit Project Proponent prefers to not conduct field sampling, whether they are under a time constraint or developing an area with high anthropogenic disturbance, a site-scale function of 100% could be assigned within the debit site-screening tool which would allow for the most conservative debit calculation possible. This would display the same function as if the field sampling determined pristine GRSG habitat. If this option is preferred over utilizing the complete HQT, it would create a systematic and consistent approach to calculating credit obligation for debit projects that would always yield a higher debit estimate than if field data were collected.

**EXAMPLE MAP UNIT CALCULATION (SITE SCALE)**

The site-scale function for each seasonal GRSG habitat type is multiplied by local-scale function and the number of acres within the map unit to calculate functional acres (Table 6).

Table 6. Example map unit calculation (site scale)

	Management Category	Meadow	3 <sup>rd</sup> Order Function	4 <sup>th</sup> Order Function	Overall Function	Acres	Functional Acres
<b>Breeding</b>	PHMA	No Meadow	38%	61%	<b>23%</b>	18	<b>4.2</b>

<b>LBR</b>	PHMA	No Meadow	36%	70%	25%	18	4.5
<b>Winter</b>	PHMA	No Meadow	28%	64%	18%	18	3.2

Map Unit 1 is located in a mesic precipitation zone (i.e., more than 10 inches (25.4 centimeters) of precipitation per year) and contains dominantly mountain big sagebrush. The following measurements are obtained during the appropriate sampling period. Each measurement is scored using the appropriate scoring curves, the score is then weighted, and the weighted scores are summed for each seasonal habitat type to calculate pre-modified site-scale function.

The map unit is also assessed for invasive annual grass and distance to sagebrush. The map unit contains sagebrush within it, yielding a score of 100% for the distance to sagebrush modifier. Invasive annual grass cover is measured at 6% during the breeding assessment and 3% during the late brood-rearing assessment, yielding scores of 100% and 80%, respectively. Modifier scores are multiplied by the pre-modified site-scale function for each seasonal GRSG habitat type in succession to calculate site-scale function.

Table 7. Pre-modified site-scale function example

	Average Measurement	Score*	Weight	Weighted Score
<b>Breeding</b>				
Sagebrush Canopy Cover	17%	85%	20%	17%
Total Shrub Canopy Cover	24%	75%	30%	23%
Perennial Forb Canopy Cover	4%	40%	25%	10%
Forb Species Richness	3 species	45%	25%	11%
<b>Pre-modified Site-Scale Breeding Function</b>				<b>61%</b>
Invasive Annual Grass	3%	100%	n/a	100%
<b>Site-Scale Breeding Function</b>				<b>61%</b>
<b>Late Brood-Rearing</b>				
Perennial Grass Canopy Cover	7%	64%	25%	16%
Perennial Forb Canopy Cover	12%	100%	37.5%	38%
Forb Species Richness	4 species	90%	37.5%	34%
<b>Pre-modified Site-Scale Late Brood-Rearing Function</b>				<b>88%</b>
Invasive Annual Grass	6%	80%	n/a	80%
Distance to Sagebrush	0 m	100%	n/a	100%
<b>Site-Scale Late Brood-Rearing Function</b>				<b>70%</b>
<b>Winter</b>				
Sagebrush Canopy Cover	17%	88%	50%	44%
Sagebrush Height	34 cm	40%	50%	20%
<b>Site-Scale Winter Function</b>				<b>64%</b>

\*See [Appendix 1](#) for all scoring curves used to assess vegetation attributes at the site scale

## 4.0 PROJECT EXAMPLE

Tables 8, 9 and 10 illustrate the scoring process for the remainder of the map units in the example credit project. The process used to evaluate Map Unit 1, described in the previous section, is repeated for each map unit.

The scoring process requires both a desktop analysis and a field analysis. The desktop analysis measures attributes at the landscape and local scale. The field analysis measures vegetation attributes relevant at the site scale. Overall GRS habitat function is a product of local-scale function and site-scale function. Functional acres are a product of GRS habitat function and the acres within the map unit. Each map unit is assessed for each seasonal GRS habitat type: breeding, late brood-rearing and winter.

For a complete, step-by-step description of the scoring process used by the HQT, please see the *CCS User's Guide*.

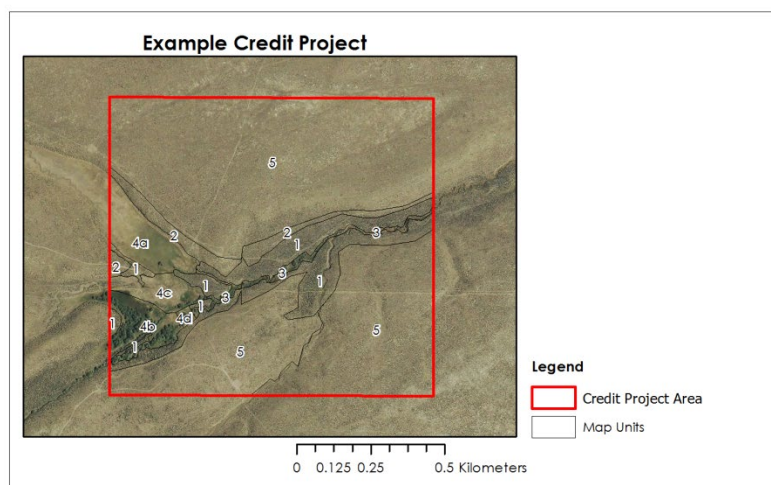

Figure 22. Example credit project and map units

Table 8. Attribute measurements, habitat function, and functional acre values for breeding habitat function

**BREEDING HABITAT FUNCTION**

Map Unit	Acres	Precipitation Regime/ Hydrologic System	Dominant Shrub Community	Management Category	Meadow System	Local-Scale Habitat Function	Site-Scale Habitat Function	Habitat Function	Functional Acres
1	18	Mesic	Big Sagebrush	PHMA	No Meadow	38%	61%	23%	4.1
2	6	Mesic	Big Sagebrush	PHMA	No Meadow	36%	46%	16%	1.0
3	2	Mesic	N/A	PHMA	Altered	38%	0%	0%	0.0
4a	6	Mesic	N/A	PHMA	Altered	35%	0%	0%	0.0
4b	5	Mesic	N/A	PHMA	Altered	37%	0%	0%	0.0
4c	4	Mesic	N/A	PHMA	Altered	36%	0%	0%	0.0
4d	0.5	Mesic	N/A	PHMA	Altered	35%	0%	0%	0.0
5	112	Mesic	Big Sagebrush	PHMA	No Meadow	38%	58%	22%	25.1

Table 9. Attribute measurements, habitat function, and functional acre values for late brood-rearing habitat function

**LATE BROOD-REARING HABITAT FUNCTION**

Map Unit	Acres	Precipitation Regime/ Hydrologic System	Dominant Shrub Community	Management Category	Meadow System	Local-Scale Habitat Function	Site-Scale Habitat Function	Habitat Function	Functional Acres
1	18	Mesic	Big Sagebrush	PHMA	No Meadow	36%	70%	25%	4.6
2	6	Mesic	Big Sagebrush	PHMA	No Meadow	35%	64%	23%	1.4
3	2	Mesic	N/A	PHMA	Altered	36%	92%	33%	0.7
4a	6	Mesic	N/A	PHMA	Altered	35%	29%	10%	0.6
4b	5	Mesic	N/A	PHMA	Altered	36%	64%	23%	1.2
4c	4	Mesic	N/A	PHMA	Altered	36%	24%	9%	0.3

4d	0.5	Mesic	N/A	PHMA	Altered	34%	58%	20%	0.1
5	112	Mesic	Big Sagebrush	PHMA	No Meadow	36%	11%	4%	4.4

Table 10. Attribute measurements, habitat function, and functional acre values for winter habitat function

**WINTER HABITAT FUNCTION**

Map Unit	Acres	Precipitation Regime/ Hydrologic System	Dominant Shrub Community	Management Category	Meadow System	Local-Scale Habitat Function	Site-Scale Habitat Function	Habitat Function	Functional Acres
1	18	Mesic	Big Sagebrush	PHMA	No Meadow	28%	64%	18%	3.3
2	6	Mesic	Big Sagebrush	PHMA	No Meadow	26%	53%	14%	0.8
3	2	Mesic	N/A	PHMA	Altered	29%	0%	0%	0.0
4a	6	Mesic	N/A	PHMA	Altered	24%	0%	0%	0.0
4b	5	Mesic	N/A	PHMA	Altered	26%	0%	0%	0.0
4c	4	Mesic	N/A	PHMA	Altered	25%	0%	0%	0.0
4d	0	Mesic	N/A	PHMA	Altered	25%	0%	0%	0.0
5	112	Mesic	Big Sagebrush	PHMA	No Meadow	29%	71%	20%	22.7

## 5.0 LIMITATIONS OF THE HQT

---

The HQT is the scientific underpinning of the Credit System. The credibility of the Credit System and its effectiveness hinges upon the quality of the science upon which it is based and the integrity with which it is applied. The HQT is based on the best available science and best professional judgment. However, there are aspects of its content and potential uses that can be improved as it is adaptively managed over time. These limitations should be considered when applying the HQT.

### LINKING TO POPULATION OUTCOMES

The ultimate objective of the Credit System is to contribute to conservation of the GRSG by providing net ecosystem benefits. However, these benefits must ultimately lead to larger and more secure GRSG populations. Therefore, the Credit System must have a means of measuring aggregate cumulative GRSG habitat impacts and benefits and relating the net contribution of benefits achieved through the Credit System to populations.

To make this link, an estimate of population impacts from activities related to credit and debit projects is needed. Unfortunately, it is not currently possible to make this link directly through published literature and thus site-level management actions cannot be quantified for the number of GRSG “produced” or “eliminated.” However, additional research could contribute to a greater understanding of how cumulative ecosystem changes contribute to population viability. Furthermore, as long as debits are offset by credits, and as credits accumulate beyond debits, the Credit System will have contributed to increases in high-quality GRSG habitat that can help to sustain resilient populations over time. The State of Nevada will continue to monitor GRSG populations across the state.

### IMPORTANCE OF TEMPORAL SCALE

Temporal scales must be taken into consideration when establishing a mitigation project, and as spatial scales of a project or evaluation area increase, so should temporal scales.

Temporal scales vary among ecological processes and may not be linear, especially in varying environments. The time required for a vegetation community to respond to management practices or changes and its influence on GRSG vital rates varies by ecosystem, geography, climate, and land use. For GRSG, time lags of two to ten years have been observed for population response to infrastructure development (Holloran and Anderson 2005, Walker et al. 2007, Harju et al. 2010) or even longer with changes in ecosystem structure (e.g., fire; Connelly et al. 2011). Temporal scale for sagebrush projects deserves especially close consideration given that recovery of sagebrush is an especially difficult and slow process due to abiotic variation, short-lived seedbanks, and long generation time of sagebrush; where soils and vegetation are highly disturbed, sagebrush restoration can be challenging if not impossible (Monsen 2005, Pyke 2011).

The scoring approach used in the HQT does not include a short-term temporal aspect. Thus, it cannot detect short-term changes in impacts resulting from infrastructure. For example, a drilling rig may have more impact than a producing well. Due to this limitation, it scores the impact based on the primary level of activity the majority of the time the disturbance is present. In this example, it scores based on the impact of the active production phase, rather than the drilling rig phase, which may only last 60 days.

### ANTHROPOGENIC IMPACTS LITERATURE

Much of the literature used to estimate the distance effects and relative weights associated with anthropogenic disturbance is derived from analyses of the response of GRSG on leks (i.e., number of males occupying leks) to that infrastructure (see [Appendix 4](#)) as leks are relatively easy to monitor and provide surrogate information for seasonal GRSG habitat quality in the vicinity of leks. As more studies become available that more explicitly quantify demographic impacts to GRSG during specific seasonal

periods (i.e., breeding, summer, and winter), weights and distances for each season may be developed to fine-tune the relative impacts by season from different types of anthropogenic activity.

Additionally, most of this literature relates to oil and gas development. Although currently in Nevada there is little oil and gas development, other energy and mineral facilities are assumed to have similar effects as oil and gas-related infrastructure. Where literature is available specific to a type of anthropogenic disturbance, that literature is used to determine indirect effect distances and weights.

### **VEGETATION SAMPLING PROTOCOL**

The HQT currently relies on a standardized, site-specific vegetation sampling protocol to establish vegetation conditions. The methods established in the User's Guide are based on the same methods that were used in the research supporting the scoring curves developed for this process. Standardizing vegetation sampling protocols over space and time has its challenges, which could be problematic in situations where quantifying vegetation change is the objective of monitoring (Seefeldt and Booth 2006). Aerial imagery and other remotely-sensed information offer the opportunity for more objective measurement of vegetation across space and time, but in most instances the products derived from these data are too coarse to effectively detect small-scale changes in the vegetation (Seefeldt and Booth 2006). As remote-sensing platforms and sensors mature, spatial and temporal resolution are expected to improve and costs decrease, making it easier to effectively quantify change in relevant vegetation attributes for attributes that can be assessed with these technologies. The Science Committee, a group of GRSG experts and scientists convened to inform monitoring efforts across the Credit System, will stay abreast of advances in remote-sensing and image analysis software so that GIS-based monitoring protocols can be incorporated into the HQT as suitable to address the HQT objectives.

### **SEASONAL GREATER SAGE-GROUSE HABITAT AVAILABILITY, INTERSPERSION & PROXIMITY**

The HQT uses the proportion of each seasonal range available to GRSG on the landscape within and surrounding a project site as a modifier of GRSG habitat quality. However, the interspersed, proximity and availability of the differing cover types used by GRSG during an annual cycle influence the effectiveness of a given landscape to provide GRSG with useable and high-quality habitat (Connelly et al. 2011). Future iterations of the HQT could explore how to integrate interspersed and proximity as modifiers of habitat function.

## 6.0 APPENDICES

---

Appendix 1. Scoring Curves

Appendix 2. Monitoring and Programmatic Improvement

Appendix 3. HQT Development and Review

Appendix 4. Sage-grouse Response to Anthropogenic Disturbance Literature Review

## APPENDIX 1. SCORING CURVES

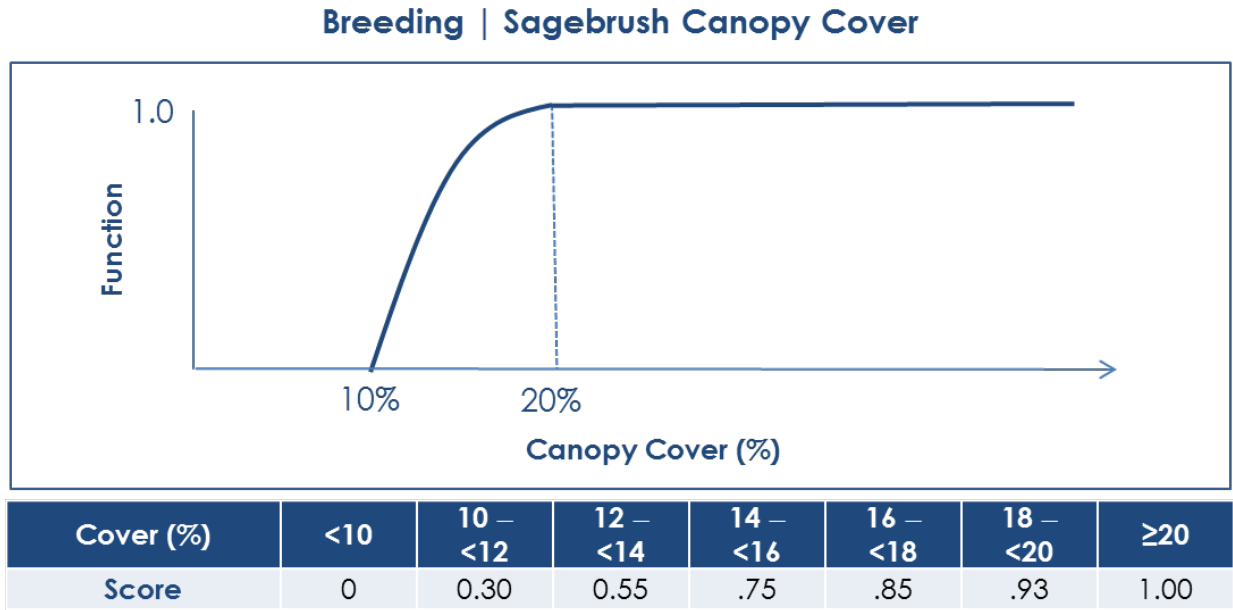

Figure 23. Scoring curve and table for sagebrush copy cover as a modifier for breeding habitat

Reference: Modified from a curve created for the Colorado Greater Sage-grouse Habitat Quantification Tool (Colorado Division of Wildlife et al. 2008), which used 20% as the starting value and 30% as the minimum fully functional value. TRG input subtracted 10% from the starting point to reflect Table 2-6 (Bureau of Land Management 2015 and references therein) and Kolada et al. 2009b, 2009a.

### Breeding | Total Shrub Canopy Cover

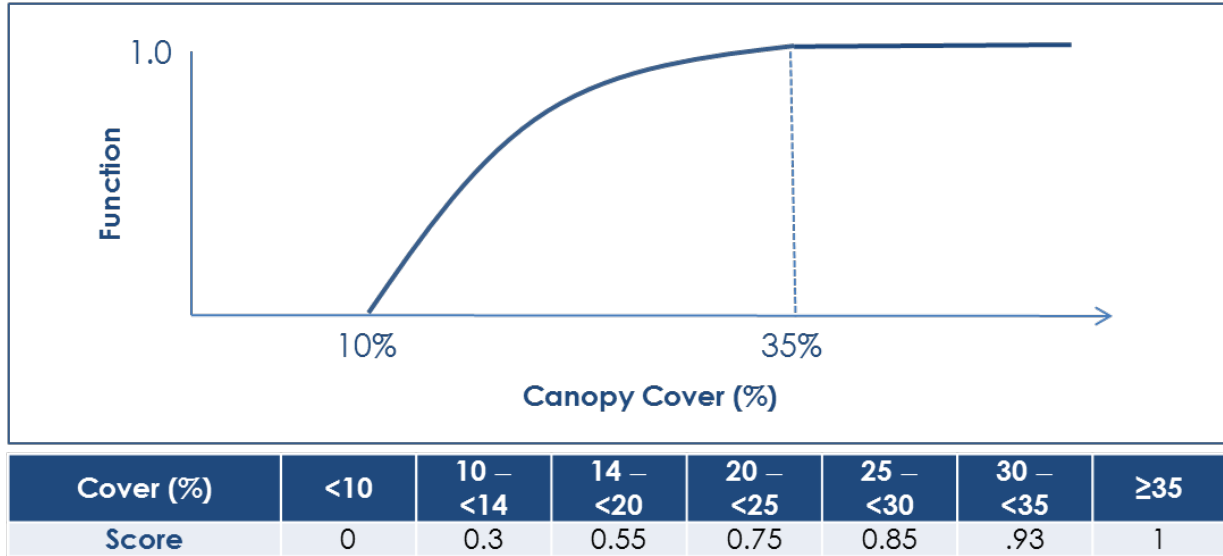

Figure 24. Scoring curve and table for total shrub canopy cover as a modifier for breeding habitat

Reference: Attribute included based on TRG input to reflect Table 2-6 (Bureau of Land Management 2015) and developed curve setting the minimum fully functional value at 35% (Kolada et al. 2009b, Coates and Delehanty 2010, Gibson et al. 2013, Lockyer et al. 2015) .

### Breeding | Perennial Forb Canopy Cover (Arid Conditions)

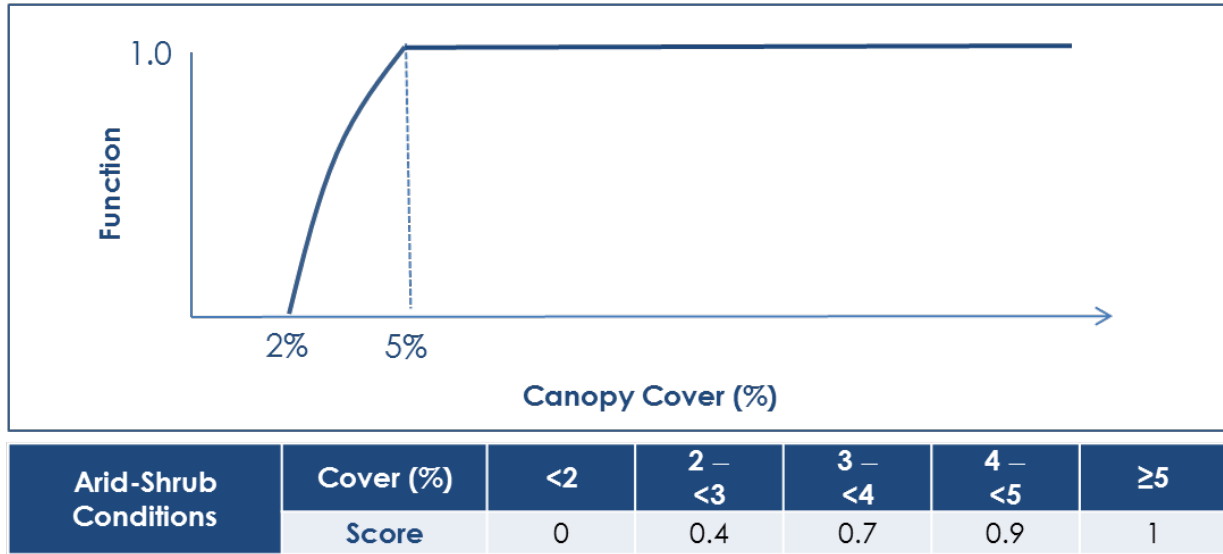
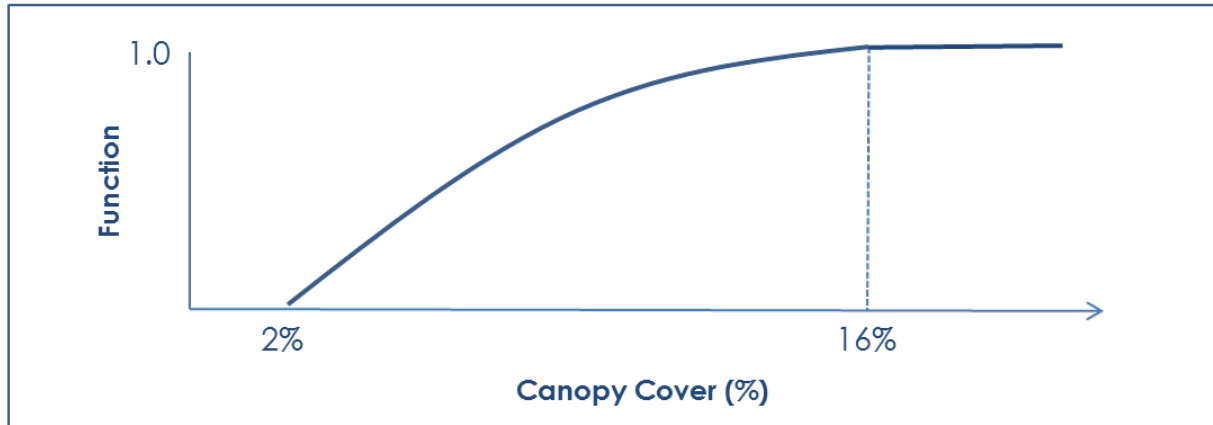

Figure 25. Scoring curve and table for perennial forb canopy cover (arid conditions) as a modifier for breeding habitat

Reference: Modified from a curve created for the Colorado Greater Sage-grouse Habitat Quantification Tool (Colorado Division of Wildlife et al. 2008), which used 20% as the minimum fully functional value and 0% as the starting value. Modified based on TRG input to reflect Table 2-6 (Bureau of Land Management 2015) to develop separate curves for arid-shrub conditions and mesic-shrub conditions/meadow systems. Based on Table 2-6 (Bureau of Land Management 2015), Casazza et al. 2011, Lockyer et al. 2015 modified the minimum fully functional value set to 5%. Based on TRG input, the starting value was set at 2% as some canopy cover is needed to meet the needs of GRSG and reflects the ability for a site to recovery after a disturbance. Curve was modified to be more linear based on unpublished data provided by J. Seding that showed increased nest selection preference and success related to increased forb cover in an almost linear relationship.

### Breeding | Perennial Forb Canopy Cover (Mesic-Shrub & Meadow Systems)



Mesic-Shrub & Meadow Systems	Cover (%)	<2	2 – <4	4 – <6	6 – <8	8 – <10	10 – <12	12 – <14	14 – <16	≥16
	Score	0	.2	.4	.55	.7	.79	.86	.93	1

Figure 26. Scoring curve and table for perennial forb canopy cover (mesic-shrub & meadow systems) as a modifier for breeding habitat

Reference: Modified from a curve created for the Colorado Greater Sage-grouse Habitat Quantification Tool (Colorado Division of Wildlife et al. 2008), which used 20% as the minimum fully functional value and 0% as the starting value. Modified based on TRG input to reflect Table 2 - 6 (Bureau of Land Management 2015) to develop separate curves for arid-shrub conditions and mesic-shrub conditions/meadow systems. Based on Table 2- 6 (Bureau of Land Management 2015), (Casazza et al. 2011, Lockyer et al. 2015) TRG input modified the minimum fully functional value set to 16%. Based on TRG input, the starting value was set at 2% as some canopy cover is needed to meet the needs of GRSG and reflects the ability for a site to recovery after a disturbance. Curve was modified to be more linear based on unpublished data provided by J. Sedinger that showed increased nest selection preference and success related to increased forb cover in an almost linear relationship.

### Breeding | Forb Species Richness (Arid Conditions)

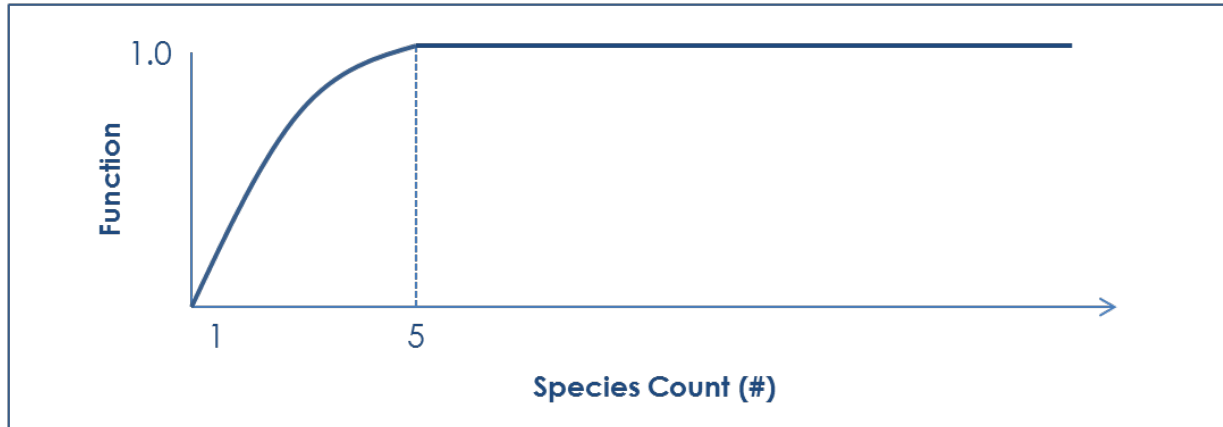

Arid-Shrub Conditions	Species (#)	<1	1 – <2	2 – <3	3 – <4	4 – <5	≥5
	Score		0	.3	.6	.75	.9

Figure 27. Scoring curve and table for forb species richness (arid conditions) as a modifier for breeding habitat

Reference: Modified from a curve created for the Colorado Greater Sage-grouse Habitat Quantification Tool (Colorado Division of Wildlife et al. 2008), which set 8 species as the minimum fully functional value and 0 species as the starting value. Adjusted based on Casazza et al. 2011, Lockyer et al. 2015, and TRG input changing starting value to be 1 forb species as having no forbs has no value and reduced the minimum fully functional value to 5 species due to lower general forb abundance in Nevada.

### Breeding | Forb Species Richness (Mesic-Shrub & Meadow Systems)

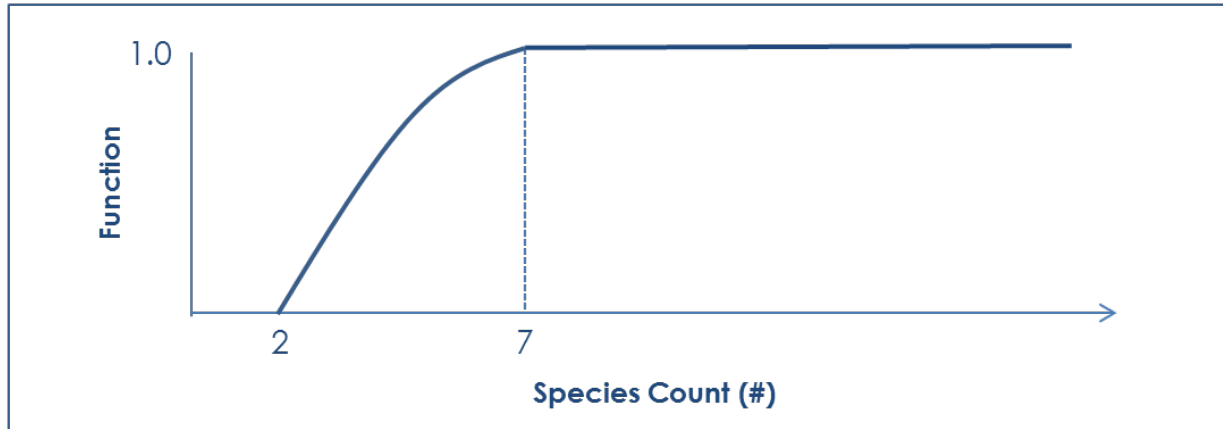

Mesic-Shrub & Meadow Systems	Species #	<2	2 – <3	3 – <4	4 – <5	5 – <6	6 – <7	≥7
	Score	0	.25	.45	.65	.8	.92	1

Figure 28. Scoring curve and table for forb species richness (mesic-shrub & meadow systems) as a modifier for breeding habitat

Reference: Modified from a curve created for the Colorado Greater Sage-grouse Habitat Quantification Tool (Colorado Division of Wildlife et al. 2008), which set 12 species as the minimum fully functional value and 0 species as the starting value. Adjusted based on Casazza et al. 2011, Lockyer et al. 2015, and TRG input changing starting value to be 2 forb species as having no forbs has no value, but expectation that mesic sites should have more species than arid, and reduced minimum fully functional value to 7 due to lower general forb abundance in Nevada.

### Late Brood-Rearing | Perennial Forb Canopy Cover (Arid Conditions)

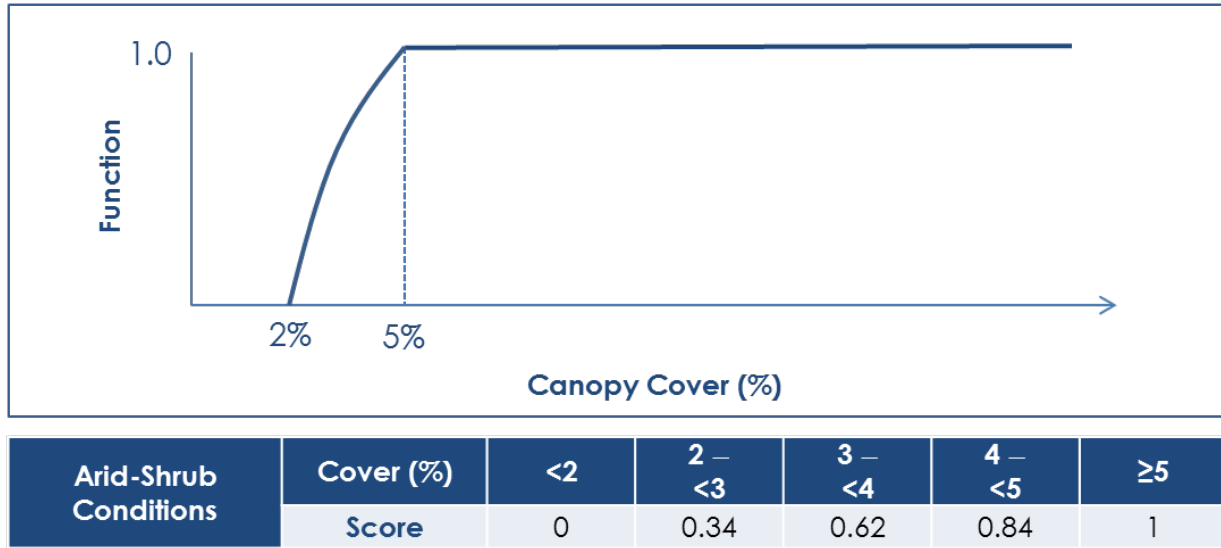
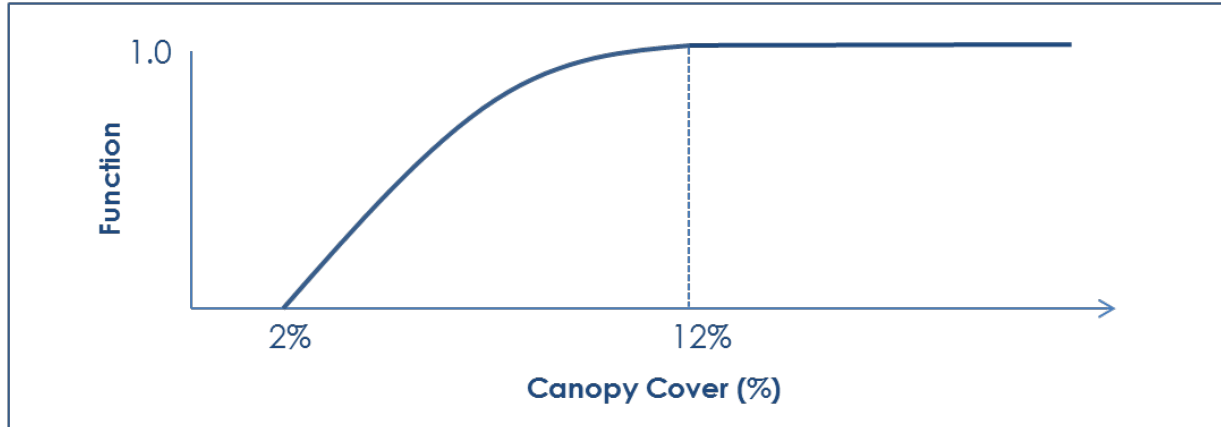

Figure 29. Scoring curve and table for perennial forb canopy cover (arid-conditions) as a modifier for late brood-rearing habitat

Reference: Modified from a curve created for the Colorado Greater Sage-grouse Habitat Quantification Tool (Colorado Division of Wildlife et al. 2008), which used 20% as the minimum fully functional value and 0% as the starting value. Modified based on TRG input to reflect Table 2-6 (Bureau of Land Management 2015) to develop separate curves for arid-shrub conditions and mesic-shrub conditions/meadow systems. Based on Table 2-6 (Bureau of Land Management 2015), Casazza et al. 2011, Lockyer et al. 2015 modified the minimum fully functional value set to 5%. Based on TRG input, the starting value was set at 2% as some canopy cover is needed to meet the needs of GRSG and reflects the ability for a site to recovery after a disturbance. Curve was modified to be more linear based on unpublished data provided by J. Sedinger that showed increased nest selection preference and success related to increased forb cover in an almost linear relationship.

### Late Brood-Rearing | Perennial Forb Canopy Cover (Mesic-Shrub Systems)



Mesic-Shrub Systems	Cover (%)	<2	2 – <4	4 – <6	6 – <8	8 – <10	10 – <12	≥12
	Score	0	.25	.45	.64	.78	.9	1

Figure 30. Scoring curve and table for perennial forb canopy cover (mesic-shrub systems) as a modifier for late brood-rearing habitat

Reference: Modified from a curve created for the Colorado Greater Sage-grouse Habitat Quantification Tool (Colorado Division of Wildlife et al. 2008), which used 20% as the minimum fully functional value and 0% as the starting value. Modified based on TRG input to reflect Table 2-6 (Bureau of Land Management 2015) to develop separate curves for arid-shrub conditions and mesic-shrub conditions/meadow systems. Based on Table 2-6 (Bureau of Land Management 2015), Casazza et al. 2011, Lockyer et al. 2015, and TRG input modified the minimum fully functional value set to 12%. Based on TRG input, the starting value was set at 2% as some canopy cover is needed to meet the needs of GRSG and reflects the ability for a site to recovery after a disturbance. Curve was modified to be more linear based on unpublished data provided by J. Sedinger that showed increased nest selection preference and success related to increased forb cover in an almost linear relationship.

### Late Brood-Rearing | Perennial Forb Canopy Cover (Meadow Systems)

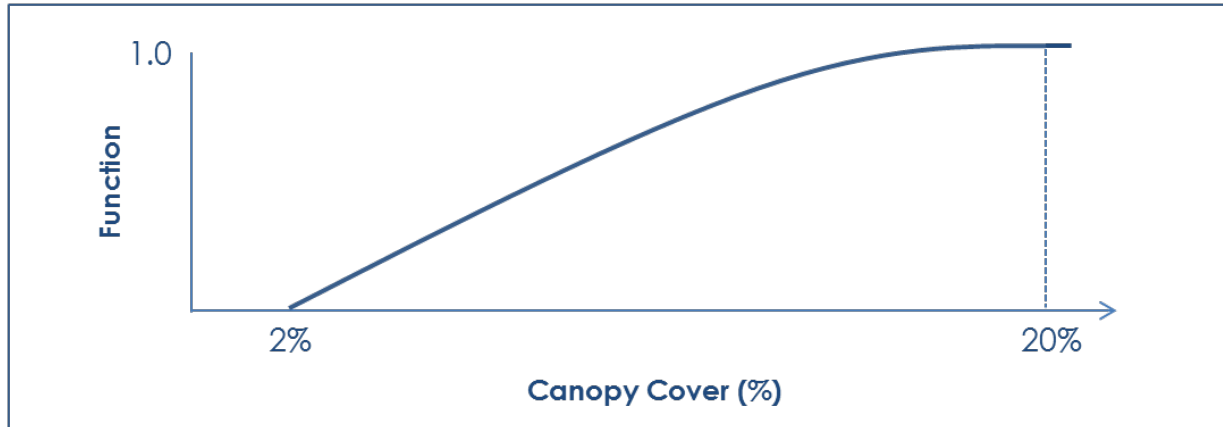

Meadow Systems	Cover (%)	<5	5 – <8	8 – <10	10 – <14	14 – <16	16 – <20	≥20
	Score	0	.25	.45	.64	.78	.9	1

Figure 31. Scoring curve and table for perennial forb canopy cover as a modifier for late brood-rearing habitat

Reference: Modified from a curve created for the Colorado Greater Sage-grouse Habitat Quantification Tool (Colorado Division of Wildlife et al. 2008), which used 20% as the minimum fully functional value and 0% as the starting value. Modified based on TRG input to reflect Table 2-6 (Bureau of Land Management 2015) to develop separate curves for arid-shrub conditions and mesic-shrub conditions/meadow systems. Based on curves for Late Brood Rearing –Perennial Forb Canopy Cover (arid-shrub and mesic-shrub conditions) and increased productivity in meadow site, TRG modified the minimum fully functional value to 20%. Based on TRG input, the starting value was set at 2% as some canopy cover is needed to meet the needs of GRSG and reflects the ability for a site to recovery after a disturbance. Curve was modified to be more linear based on unpublished data provided by J. Sedinger that showed increased nest selection preference and success related to increased forb cover in an almost linear relationship.

### Late Brood-Rearing | Forb Species Richness (Arid Conditions)

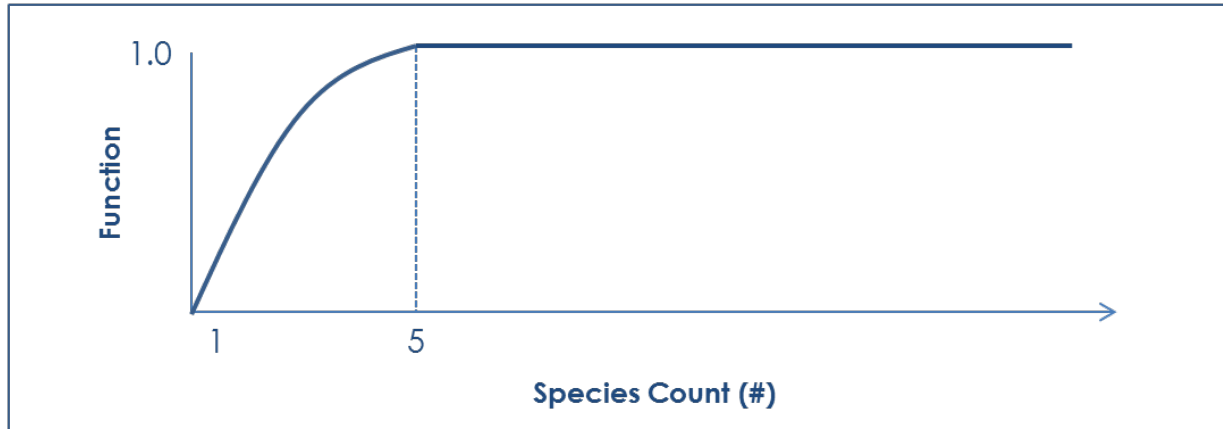

Arid-Shrub Conditions	Species (#)	<1	1 – <2	2 – <3	3 – <4	4 – <5	≥5
	Score		0	.3	.6	.75	.9

Figure 32. Scoring curve and table for forb species richness (arid conditions) as a modifier for late brood-rearing habitat

Reference: Modified from a curve created for the Colorado Greater Sage-grouse Habitat Quantification Tool (Colorado Division of Wildlife et al. 2008), which set 8 species as the minimum fully functional value and 0 species as the starting value. Adjusted based on Casazza et al. 2011, Lockyer et al. 2015, and TRG input changing starting value to be 1 forb species as having no forbs has no value and reduced the minimum fully functional value to 5 species due to lower general forb abundance in Nevada.

**Late Brood-Rearing | Forb Species Richness (Mesic-Shrub & Meadow Systems)**

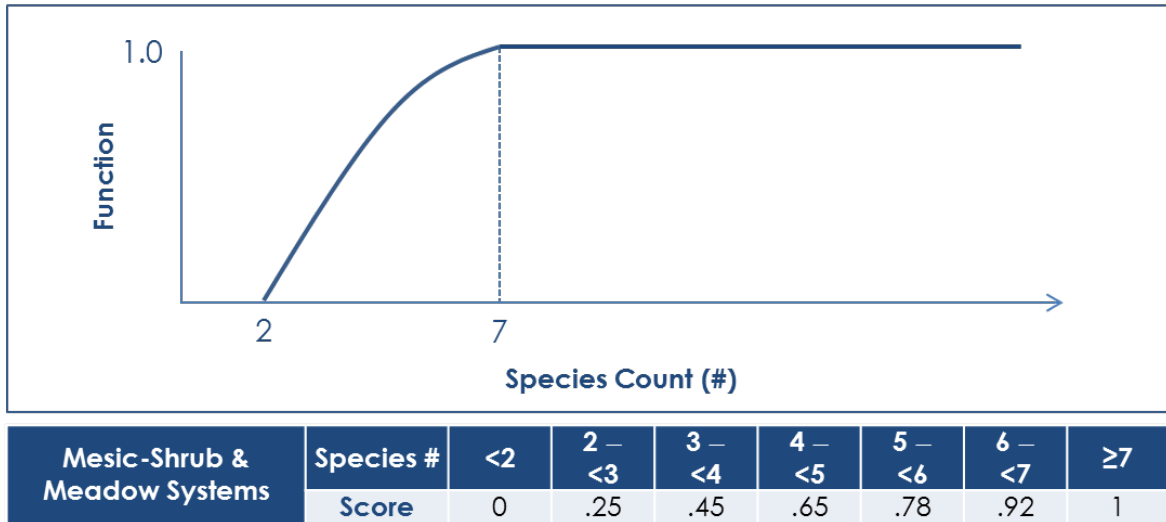
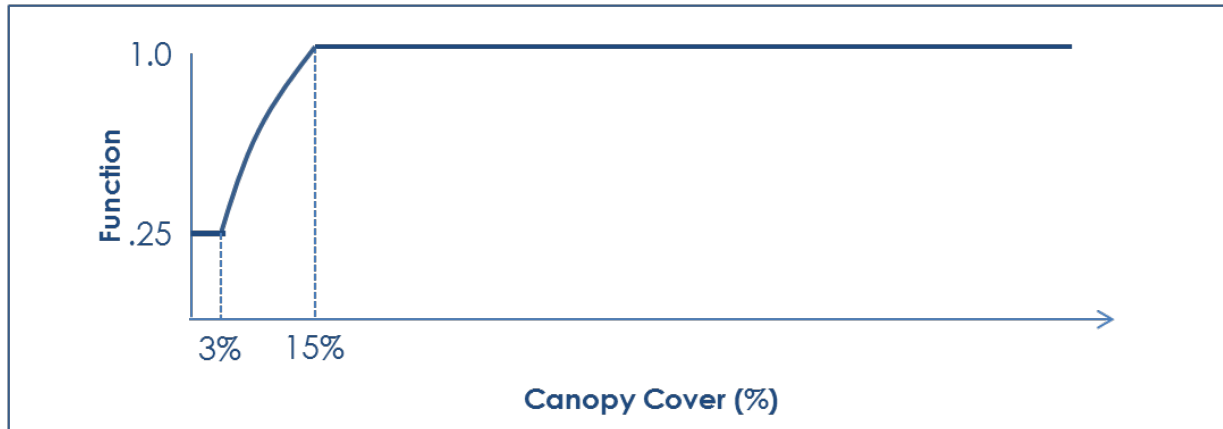

Figure 33. Scoring curve and table for forb species richness (mesic-shrub & meadow systems as a modifier for late brood-rearing habitat

Reference: Modified from a curve created for the Colorado Greater Sage-grouse Habitat Quantification Tool (Colorado Division of Wildlife et al. 2008), which set 12 species as the minimum fully functional value and 0 species as the starting value. Adjusted based on Casazza et al. 2011, Lockyer et al. 2015, and TRG input changing starting value to be 2 forb species as having no forbs has no value, but expectation that mesic sites should have more species than arid, and reduced minimum fully functional value to 7 due to lower general forb abundance in Nevada.

### Late Brood-Rearing | Perennial Grass Canopy Cover (Arid Conditions)



Arid-Shrub Conditions	Cover (%)	<3	3 – <6	6 – <9	9 – <12	12 – <15	≥15
	Score	.25	.45	.64	.78	.92	1

Figure 34. Scoring curve and table for perennial grass canopy cover (arid conditions) as a modifier for late brood-rearing habitat

Reference: Attribute included based on TRG input to reflect Table 2-6 (Bureau of Land Management 2015) and curved based on Connelly et al. 2000, Hagen et al. 2009 which provided support for 15% as the minimum fully functional value. The late brood-rearing perennial grass canopy cover curve was further informed by Kiriol 2012, which found perennial grass cover was 17.4% in selected sites, and 12% in non-selected sites.

### Late Brood-Rearing | Perennial Grass Canopy Cover (Mesic-Shrub Systems)

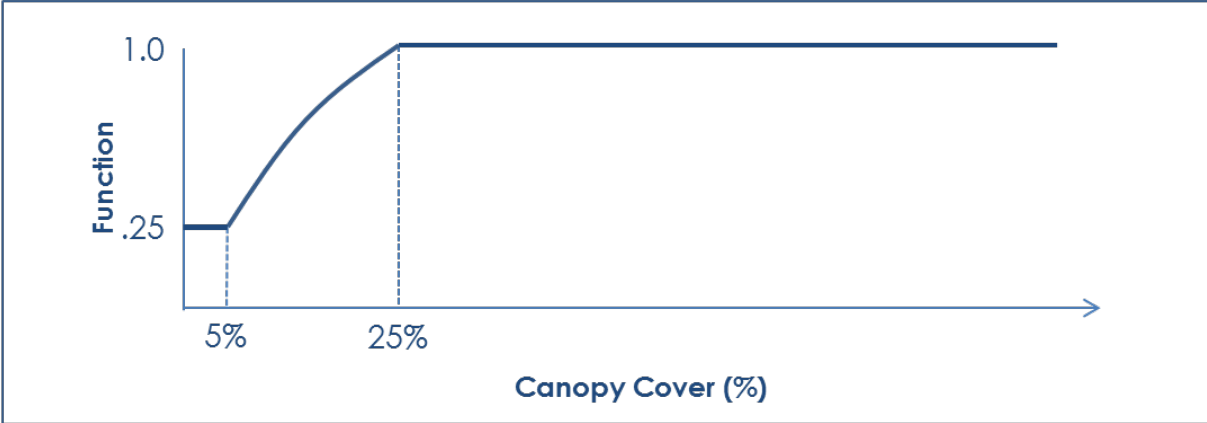

Mesic-Shrub Systems	Cover (%)	<5	5 – <10	10 – <15	15 – <20	20 – <25	≥25
	Score	.25	.45	.64	.78	.92	1

Figure 35. Scoring curve and table for perennial grass canopy cover (mesic-shrub systems) as a modifier for late brood-rearing habitat

Reference: Attribute included based on TRG input to reflect Table 2-6 (Bureau of Land Management 2015) and curved based on Connelly et al. 2000, Hagen et al. 2009 which provided support for 15% as the minimum fully functional value for arid sites. TRG recommended different curves for arid-shrub conditions, mesic-shrub conditions and meadow systems. Starting and minimum fully functional values for mesic-shrub conditions were increased to 25% due to higher levels of productivity.

### Late Brood-Rearing | Perennial Grass Canopy Cover (Meadow Systems)

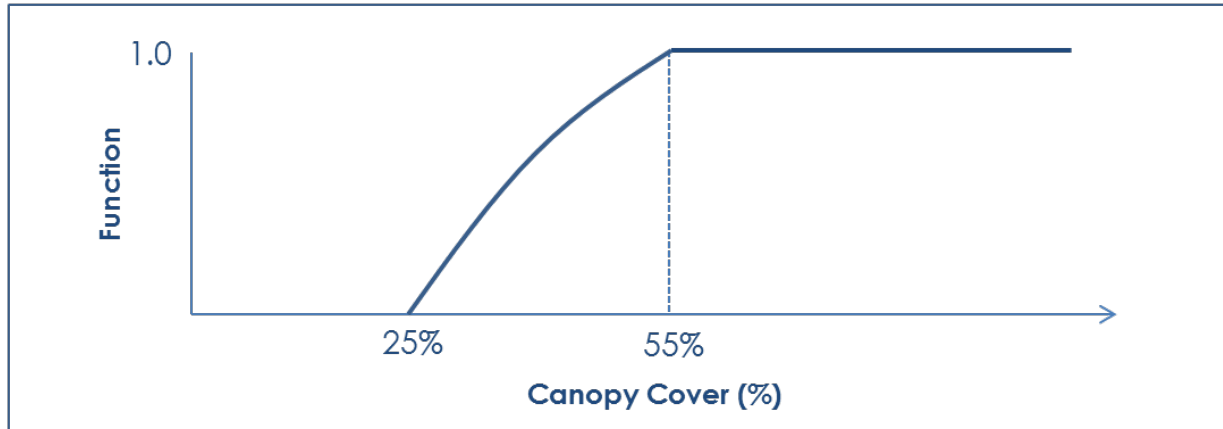

Meadow Systems	Cover (%)	<25	25 – <30	30 – <35	35 – <40	40 – <45	45 – <50	50 – <55	≥55
	Score	0	.23	.42	.58	.7	.82	.94	1

Figure 36. Scoring curve and table for perennial grass canopy cover (meadow systems) as a modifier for late brood-rearing habitat

Reference: Attribute included based on TRG input to reflect Table 2-6 (Bureau of Land Management 2015) and curved based on Connelly et al. 2000, Hagen et al. 2009 which provided support for 15% as the minimum fully functional value for arid sites. TRG recommended different curves for arid-shrub conditions, mesic-shrub conditions and meadow systems. Starting and minimum fully functional values for mesic-shrub conditions were increased to 55% due to higher levels of productivity.

### Winter | Sagebrush Height (Dominantly Big Sagebrush)

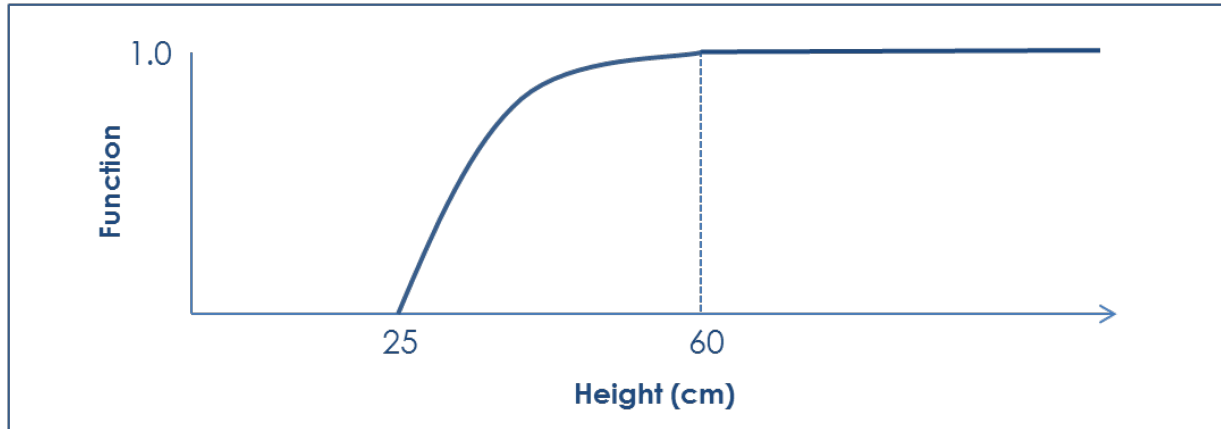

Dominantly Big Sagebrush	Height (cm)	<25	25 – <30	30 – <35	35 – <40	40 – <45	45 – <50	50 – <55	55 – <60	≥60
	Score	0	.2	.4	.55	.62	0.68	.84	.92	1

Figure 37. Scoring curve and table for sagebrush height (dominantly big sagebrush) as a modifier for winter habitat

Reference: Modified from a curve created for the Colorado Greater Sage-grouse Habitat Quantification Tool (Colorado Division of Wildlife et al. 2008), which set the minimum fully functional value at 15.7 inches (40 centimeters) and the starting point at 7.87 inches (20 centimeters) for slope < 5%, and 7.87 inches (20 centimeters) as the minimum fully functional value and 3.94 inches (10 centimeters) as the starting point for slope > 5%. TRG input developed different curves for different sagebrush systems (big sage versus low/black sage), instead of differentiating by slope and aspect and mesic vs. arid, as this is less complicated to determine and likely to be more reflective of sagebrush heights snow levels given different inherent size of sagebrush species and snow depths relative to sagebrush/ species communities. For big sagebrush species, TRG modified the minimum fully functional value to 23.6 inches (60 centimeters) to focus conservation of winter sites in areas that are key during heavy winters and that Connelly et al. 2000 recommendation of 9.84 inches (25 centimeters) *above snow level*, but that measurements for the Nevada Credit System will be occurring when there is no snow.

### Winter | Sagebrush Height (Dominantly Low or Black Sagebrush)

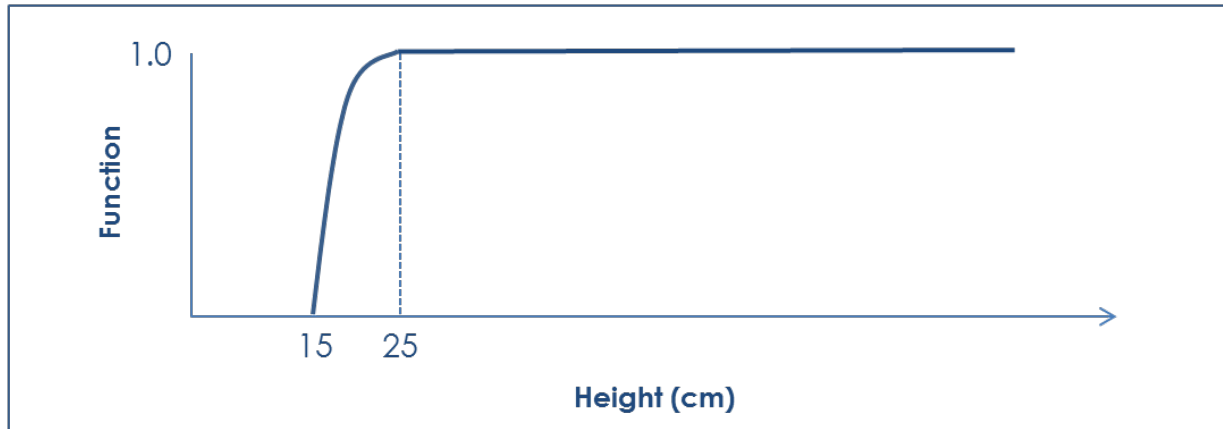

Dominantly Low or Black Sagebrush	Height (cm)	<15	15 – <17	17 – <19	19 – <21	21 – <23	23 – <25	≥25
	Score	0	.25	.45	.6	.75	.9	1

Figure 38. Scoring curve and table for sagebrush height (dominantly low or black sagebrush) as a modifier for winter habitat

Reference: Modified from a curve created for the Colorado Greater Sage-grouse Habitat Quantification Tool (Colorado Division of Wildlife et al. 2008), which set the minimum fully functional value at 15.7 inches (40 centimeters) and the starting point at 7.87 inches (20 centimeters) for slope < 5%, and 7.87 inches (20 centimeters) as the minimum fully functional value and 3.94 inches (10 centimeters) as the starting point for slope > 5%. TRG input developed different curves for different sagebrush systems (big sage versus low/black sage), instead of differentiating by slope and aspect and mesic vs. arid, as this is less complicated to determine and likely to be more reflective of sagebrush heights snow levels given different inherent size of sagebrush species and snow depths relative to sagebrush/ species communities. This is lower than big sagebrush communities’ curve because of the inherently shorter stature of low/black sagebrush communities and that snow generally does not last as long (wind, solar radiation) in these communities as in big sagebrush communities.

### Winter | Sagebrush Canopy Cover (Dominantly Big Sagebrush)

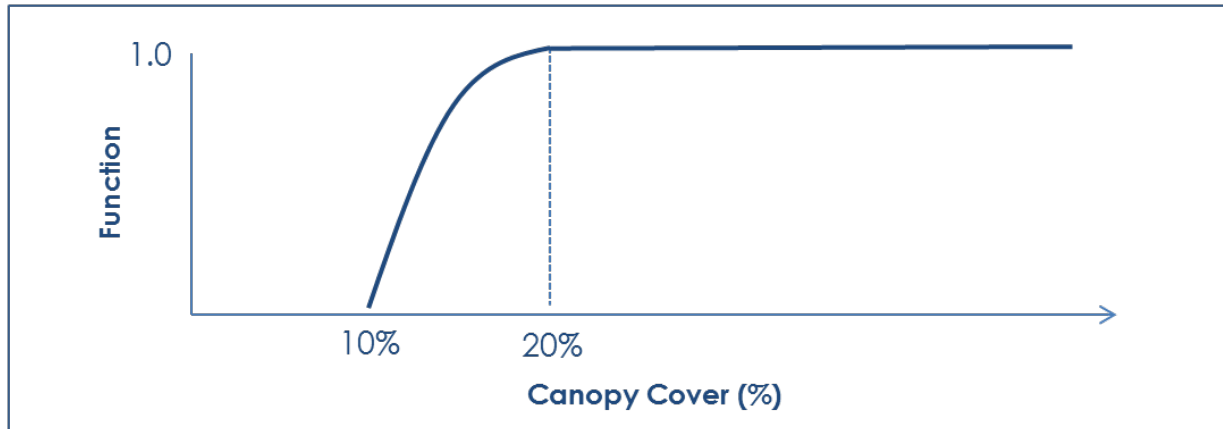

Dominantly Big Sagebrush	Cover (%)	<10	10 – <12	12 – <14	14 – <16	16 – <18	18 – <20	≥20
	Score	0	.3	.55	.75	.88	.95	1

Figure 39. Scoring curve and table for sagebrush canopy cover (dominantly big sagebrush) as a modifier for winter habitat

Reference: Modified from a curve created for the Colorado Greater Sage-grouse Habitat Quantification Tool (Colorado Division of Wildlife et al. 2008), which set the minimum fully functional value at 30% and the starting value at 20%. TRG input developed different curves for different sagebrush systems (big sage versus low/black sage), instead of differentiating by slope and aspect and mesic vs. arid, as this is less complicated to determine and likely to be more reflective of sagebrush canopy cover above snow levels given different inherent size of sagebrush species and snow depths relative to sagebrush/ species communities. For big sagebrush species, TRG input kept same value as Colorado Habitat Exchanged and justified that based on Connelly et al. 2000 recommendation of 10% *above snow level*, but that measurements for the Nevada Credit System will be occurring when there is no snow.

### Winter | Sagebrush Canopy Cover (Dominantly Low or Black Sagebrush)

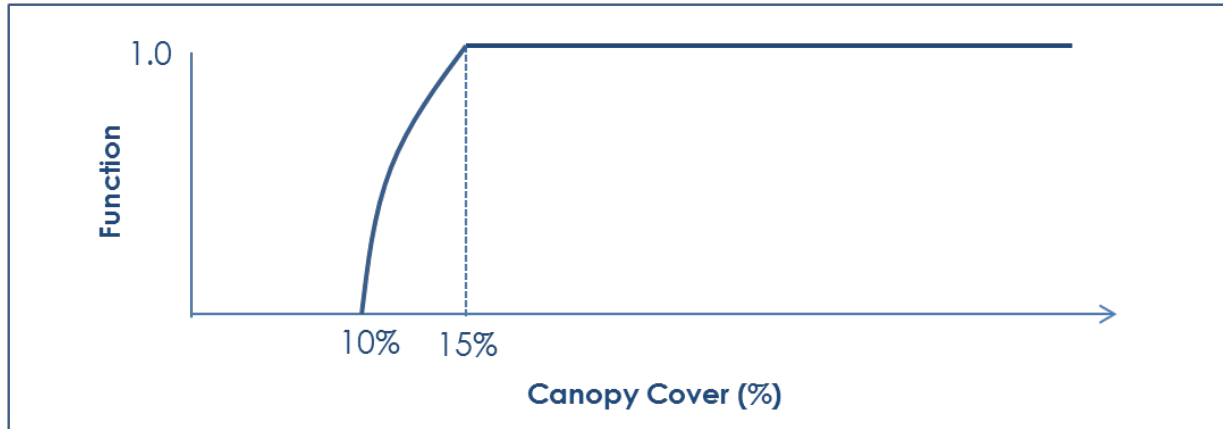

Dominantly Low or Black Sagebrush	Cover (%)	<10	10 – <11	11 – <12	12 – <13	13 – <14	14 – <15	≥15
	Score	0	.3	.55	.75	.88	.95	1

Figure 40. Scoring curve and table for sagebrush canopy cover (dominantly low or black sagebrush) as a modifier for winter habitat

Reference: Modified from a curve created for the Colorado Greater Sage-grouse Habitat Quantification Tool (Colorado Division of Wildlife et al. 2008), which set the minimum fully functional value at 30% and the starting value at 20%. TRG input developed different curves for different sagebrush systems (big sage versus low/black sage), instead of differentiating by slope and aspect and mesic vs. arid, as this is less complicated to determine and likely to be more reflective of sagebrush canopy cover above snow levels given different inherent size of sage species and snow depths relative to sage species communities. For low/black sagebrush species, TRG input moved the minimum fully functional value to 15% based on Connelly et al. 2000 recommendation of 10% *above snow level*, but that measurements for the Nevada Credit System will be occurring when there is no snow. This is lower than big sagebrush communities’ curve because in low/black sagebrush communities snow generally does not last as long (wind, solar radiation) as in big sagebrush communities.

---

## APPENDIX 2. MONITORING & PROGRAMMATIC IMPROVEMENT

---

This section is divided into two subsections: Tool Evaluation and CCS Management System. The descriptions provided here represent only guidelines for monitoring and programmatic improvement and not a *plan* for carrying out these activities. Monitoring should be highly coordinated with federal land agency monitoring efforts.

### TOOL EVALUATION

---

Tool evaluation is defined as collection and analysis of data that pertains to the functionality and performance of the HQT. In particular, tool evaluation is concerned with 1) Accuracy of the scores in measuring real and expected outcomes; 2) Utility (ease of use, efficiency, and cost) for a variety of users; 3) Repeatability of scores from one user to the next; and 4) Reliability of scores over time.

### CCS MANAGEMENT SYSTEM

---

The CCS Management System is a formal, structured, programmatic adaptive approach to dealing with uncertainty in natural resources management, using the experience of management and the results of research as an ongoing feedback loop for continuous improvement. The CCS Management System requires an ongoing flow of information from 1) research and monitoring activities conducted by scientists, 2) the practical experiences of Credit Developers and Buyers, and 3) changing context from stakeholders to inform Credit System improvements. A systematic and transparent decision-making process ensures that improvements to the Credit System do not cause uncertainty for participants. Figure 42 provides an overview of the CCS Management Steps (*Open Standards for the Practice of Conservation* 2020).

Programmatic Improvement is used in the CCS Management System to refine and update the HQT over time. In other words, none of the content or components of the HQT are meant to be static in time, rather the HQT is intended to evolve over time as needed according to new science and monitoring. The goal of programmatic improvement for the HQT is to make periodic changes that keep it up to date with the current state of ecological knowledge.

As specified in the CCS Manual, the Credit System Administrator performs the day-to-day functions to manage the Credit System. The Administrator is accountable to the Oversight Committee (Sagebrush Ecosystem Council), which approves all changes to the CCS Manual, HQT and other tools.

The Administrator convenes a Science Committee consisting of subject matter experts and scientists to inform the development and revisions of technical decisions, products and tools, like the HQT. The Science Committee meets periodically to review and evaluate new information and research on GRSG and its habitat. The Science Committee then makes recommendations to the Credit System Administrator, based on the best-available science regarding the GRSG and sagebrush ecosystems. This review and evaluation process is also used to assess the overall status of the covered species, Credit System implementation and progress, and whether any adjustments are needed to the products and tools to further ensure conservation benefits to the species.

The Administrator decides whether any specific modifications are necessary according to Science Committee recommendations, and then the Administrator makes a recommendation regarding such modifications to the Oversight Committee. The Oversight Committee confers about the Science Committee's findings and Administrator's recommendations. Any modifications to the HQT are not applied retroactively.

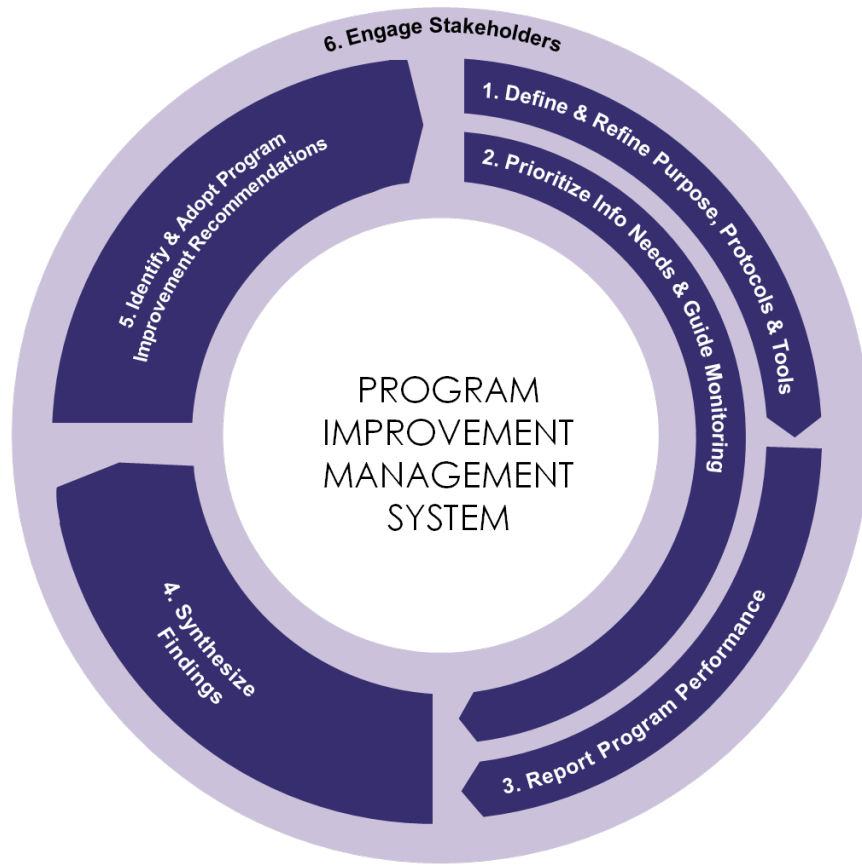

Figure 41. Steps in the credit system programmatic improvement process

---

## APPENDIX 3. HQT DEVELOPMENT & REVIEW

---

The HQT is the scientific tool used in the Credit System. It is the approach to measure impacts and benefits and is based on the best available science. Science-related elements of the Credit System that are not entirely based on science (e.g. mitigation ratio factor related to the proximity of credits and debits) are defined in the CCS Manual. The credibility of the Credit System and its effectiveness in generating net benefit for the species hinges upon the quality of the science upon which it is based and the integrity with which it is applied. It is therefore important to maintain the scientific integrity of the HQT over time as new science and implementation monitoring becomes available.

The HQT is not static. It is a working document that changes over time through the development and review processes outlined below as new scientific information becomes available. Transparent, fair, and consistent review processes are essential to ensure that the best and most recent scientific information is used incorporated over time.

Like any significant change to the Credit System, and changes to the HQT are under the control of the Oversight Committee, and the Administrator according to CCS Management System. As such, the Administrator oversees the process of development and review, and the Oversight Committee approves all changes to the HQT.

---

### INTERNAL DEVELOPMENT & REVIEW

---

#### INTERNAL DEVELOPMENT

Internal development of the HQT was conducted by the Administrator in collaboration with consultants. Tasks associated included reviewing and compiling scientific information, developing concept models and scoring curves, and writing the HQT documents.

#### ANNUAL IMPROVEMENT

Annual improvement of the HQT is conducted by the Administrator with the Sagebrush Ecosystem Council. The Sagebrush Ecosystem Council will determine, with suggestions from the Sagebrush Ecosystem Technical Team, whether the Technical Review Group is needed to develop changes to the HQT. Tasks associated with annual improvement include reviewing and compiling newly published scientific information, conducting research and monitoring, and revising HQT documents. While the HQT is in the annual improvement stage, decision-making and control over the content of the HQT is the responsibility of the Administrator. The Administrator should declare any real or perceived conflict of interest with stakeholders, including offers or acceptance of funding.

#### INTERNAL REVIEW

Internal review is conducted by official members of the Technical Review Group. During internal review, members of the Technical Review Group are given the first opportunity to provide comments on the HQT. Internal review comments from the Technical Review Group adhere to the following format and principles:

- **Confidential:** internal reviewers may not share the draft HQT with any non-official members of the group at this stage, unless those people are experts or consultants within their own organizations.
- **Constructive, practical, and cooperative:** we expect comments to come from a positive spirit of cooperation, to improve the potential for the Credit System to meet its goals in a practical manner.
- **Documented:** all comments must be referenced and supported by scientific support (e.g. peer-reviewed research), independent analysis, expert opinion with a citation of “personal communication,” and/or a thorough, clear rationale. Reviewers clearly state the source of

documentation they are using. General preferences and opinions are useful and welcomed but may not be sufficient for incorporation into the HQT. All committee participants are listed by name unless they request to remain anonymous, in which case they are acknowledged as an “anonymous reviewer.”

## APPENDIX 4. SAGE-GROUSE RESPONSE TO ANTHROPOGENIC DISTURBANCE LITERATURE REVIEW

---

### DISTANCE TO ENERGY DEVELOPMENT

---

Researchers have reported indirect effects associated with the infrastructure of energy fields whereby GRSG on leks are negatively influenced to a greater extent if infrastructure is placed near the lek, with the response diminishing as distances from lek to infrastructure increase (Manier et al. 2013). Additionally, the distance-effect of infrastructure with higher levels of human activity may be larger than that of infrastructure with lower levels of activity. Harju et al. (2010) reported that impacts to lekking sage-grouse of well pads located at shorter distances to leks were more consistently observed across energy fields compared to well pads at longer distances. There was a consistent pattern whereby the presence of well pads within smaller radii buffers (< 0.99 – 1.24 miles (< 1.6 – 2 kilometers)) around leks in extensively developed areas was associated with 35 - 76% fewer sage-grouse males on leks compared to leks with no well pads within these radii (Harju et al. 2010). Walker et al. (2007) found a strong negative effect of infrastructure within 0.50 and 1.99 miles (0.8 and 3.2 kilometers) of leks on lek persistence, with lesser impacts to lek persistence apparent at 3.98 miles (6.4 kilometers). Holloran et al. (2010) reported that impacts of development to the number of males occupying leks were greatest when infrastructure was located near the lek and attendance declined approximately 75% within 1 km of a major haul road, but that impacts were discernable to 1.86 miles (3 kilometers) for lower activity sites (producing well pads) and 3.73 miles (6 kilometers) for higher activity sites (drilling rigs). Johnson et al. (2011) reported negative lek trends for leks within approximately 2.49 miles (4 kilometers) of a producing well pad across the range of the species. Additionally, distance effects of infrastructure have been noted for other seasonal periods. Carpenter et al. (2010) found that sage-grouse avoided areas within 1.18 miles (1.9 kilometers) of infrastructure during the winter. Holloran et al. (2010) reported that yearling females avoided nesting within 3,116.8 feet (950 meter) of well pads. Annual survival of sage-grouse chicks reared near gas field infrastructure was lower than those reared away from infrastructure, and the probability of male chicks reared near infrastructure establishing a breeding territory as a yearling was half that of male chicks reared away from infrastructure (Holloran et al. 2010). Dzialak et al. (2011) reported that the closer a nest was to a natural gas well (that existed or was installed in the previous year), the more likely it was to fail. LeBeau (2012) reported that the risk of a nest or a brood failing decreased by 7.1% and 38.1%, respectively, with every 0.62 mile (1 kilometer) increase in distance from the nearest wind turbine; however, no variation in female survival was detected relative to wind energy infrastructure.

Manier et al. (2014) completed a synthesis analysis that identified literature minimum and maximum distance effects for six categories of anthropogenic land use and activity. From these they developed interpreted ranges that indicate a generalized effect area that are capped by diminishing gains analysis. For energy development, the literature minimum is 3.2 km (2 mi; Naugle et al. 2011), literature maximum is 20 km (12.4 mi; Johnson et al. 2011), and interpreted range is 5 km (3.1 mi) to 8 km (5 mi).

### DENSITY OF ENERGY DEVELOPMENT

---

Substantial amounts of research suggest that increased infrastructure densities around leks will negatively influence sage-grouse. Harju et al. (2010) reported that well pad densities of 4 and 8 pads/section (square mile) within 5.28 miles (8.5 kilometers) of leks were associated with lek count declines ranging from 13-74% and 77 - 79%, respectively. Doherty et al. (2010) reported that impacts to leks were indiscernible at well pad densities at or below 1 pad/section within 1.99 miles (3.2 kilometers) of leks, but that lek loss and declines in numbers of males on leks increased at greater pad densities. Holloran and Anderson (2005) reported that well densities exceeding 1 well/section within 1.86 miles (3 kilometers) of leks negatively influenced male lek attendance. Hess and Beck (2012) reported 0% probability of lek

occurrence in areas with well pad densities exceeding 6.5 pads/section within 0.62 miles (1 kilometer). Tack (2009) reported that larger leks (> 25 males) did not occur in areas where well pad densities exceeded 2.5 pads/section within 7.64 miles (12.3 kilometers) of a lek. Johnson et al. (2011) found a generally negative trend in lek counts as numbers of producing wells increased within 3.11 and 11.18 miles (5 and 18 kilometers) of leks. Kirol (2012) reported that females avoided nesting and rearing broods in areas with increased numbers of visible wells within a 0.62 square mile (1 square kilometer) area. Aldridge and Boyce (2007) reported that chick survival decreased with increasing numbers of visible wells within 0.62 mile (1 kilometer) of brood-rearing locations. Doherty et al. (2008) found that sage-grouse were 1.3 times more likely to occupy winter habitat with no gas field infrastructure within a 2.49 square mile (4 square kilometer) area compared to areas with 12.3 pads (8 pads/section).

---

## MINING

---

The specific impacts of mining on sage-grouse and their habitat have not been studied in the peer reviewed literature (Manier 2014). However, mining and its associated facilities and infrastructure result in ecosystem fragmentation, direct species' habitat loss, and indirect impacts decreasing the suitability of otherwise high-quality areas (U.S. Fish and Wildlife Service. 2013). Manier (2014) found for surface disturbances a literature minimum of 3.2 km (2 mi; Holloran and Anderson 2005), literature maximum is 20 km (12.4 mi; Johnson et al. 2011), and interpreted range is 5 km (3.1 mi) to 8 km (5 mi). For activities, the literature minimum is 400 m (0.12 mi; Blickley et al. 2012), literature maximum is 4.8 km (3 mi), and interpreted range is 400 m (0.12 mi) to 4.8 km (3 mi).

The magnitude of the impacts of mining activities on sage-grouse and sagebrush ecosystems is largely unquantified (Braun 1998). Development of surface mines and associated infrastructure (e.g., roads and power lines), noise and human activity negatively impact sage-grouse numbers in the short term (Braun 1998). The number of displaying sage-grouse on two leks within 1.24 miles (2 kilometers) of active coal mines in northern Colorado declined by approximately 94% over a 5-year period following an increase in mining activity (Remington and Braun 1991). However, Braun (1998) reports that studies in Montana, Wyoming and Colorado suggest that some recovery of populations occurred after initial development and subsequent reclamation of mine sites, although populations did not recover to pre-development sizes. Additionally, population re-establishment may take upwards of 30 years (Braun 1998).

---

## NOISE

---

Blickley et al. (2012) report that peak male attendance (i.e., abundance) at leks experimentally treated with noise recorded at roads in a natural gas field decreased 73% relative to paired controls. The authors reported that the intermittent nature of noise from roads impacted male sage-grouse to a greater degree than more constant noise as that from a drilling rig; peak male attendance at leks treated with noise from natural gas drilling rigs decreased 29% relative to paired controls (Blickley et al. 2012).

Noise is not directly addressed in the HQT. However, the potential differential effects of noise on sage-grouse relative to activity levels associated with infrastructure are accounted for in the indirect effects, and associated response curves, used to establish anthropogenic disturbances distances and weights.

---

## ROADS

---

Sage-grouse avoidance of high-activity roads is well documented. Connelly et al. (2004) found that no leks occurred within 1.24 miles (2 kilometers) of interstate 80, there were fewer leks within 4.66 miles (7.5 kilometers) than within 9.32 miles (15 kilometers) of the interstate, and there were higher rates of decline in lek counts between 1970 and 2003 on leks located within 4.66 miles (7.5 kilometers) compared to beyond 4.66 miles (7.5 kilometers) of the interstate. Knick et al. (2013) reported that high suitability was associated with < 0.62 miles/square mile (< 1.0 kilometers/square kilometer) of secondary roads, 0.03 miles/square mile (0.05 kilometers/square kilometer) of highways, and 0.0062 miles/square mile (0.01 kilometers/square kilometer) of interstate highways within 3.1 miles (5-kilometer) radius areas. LeBeau

(2012) found that sage-grouse avoided nesting and summering near major roads (e.g., paved secondary highways). Tack (2009) found negative relationships with more roads around leks at all levels of lek attendance, but impacts were greatest for larger leks (> 25 males); the probability of occurrence of a large lek was 50% with road densities of approximately 15.5 miles (25 kilometers) of road within 1.99 miles (3.2 kilometers) of a lek. Dzialak et al. (2011) documented sage-grouse during the winter avoiding haul roads associated with natural gas development. In contrast, Johnson et al. (2011) found negative trends in counts of males on leks throughout the range of the species with increasing distance to interstate highway—although few leks occurred near interstates; relatively consistent slight negative trends in lek counts with distance to highways; and no relationship between distance to secondary roads and lek trends. Road densities within 3.1 miles (5 kilometers) radii of leks suggested similar relationships by road category (Johnson et al. 2011).

Manier (2014) found for linear features a literature minimum of 400 m (0.25 mi; Blickley et al. 2012), literature maximum is 18 km (11.2 mi; Johnson et al. 2011), and interpreted range is 5 km (3.1 mi) to 8 km (5 mi).

---

## RAILWAYS

---

Railways and trains can negatively affect wildlife and the environment in ways similar to roads and vehicles (including wildlife mortality, species' habitat loss and fragmentation, and disturbance; (Knick and Connelly 2011), but the degree of these impacts may differ (Dorsey et al. 2015). Some authors suggest that the impacts of trains may be less than roads due to the infrequency of trains (Barrientos et al. 2019), but not much research has been done on the differences between railway and road impacts on wildlife nor on the effects of railways specifically, especially in regard to ground-dwelling birds.

Existing railways in Nevada (with the exception of the Nevada Northern Railway Museum tour line) that fall within sage-grouse habitat run approximately eight trains per day to 20 or more trains, depending on location (Hill, 1991, NDOT 2012). With the frequency, speed, and noise associated with railways, it is most appropriate to use the High Use Road weight and distance classification for inclusion within the Railway category. The museum railway runs seasonally and typically runs two trains per day. For this reason, the museum railway assigned a weight of 25% and distance of 1km similar to the Low Use Road category.

---

## TRAFFIC

---

Remington and Braun (1991) reported that the upgrade of a haul road accessing a coal mine was correlated with a 94% decline in the number of sage-grouse on leks <1.24 miles (<2 kilometers) from the road over a 5-year period; traffic speed was not measured but the potential for increased speed was inferred from upgraded road surface. Holloran and Anderson (2005) reported that declines in lek counts on leks within 1.86 miles (3 kilometers) of roads were positively correlated with increased traffic volumes and that vehicle activity on roads within 1.86 miles (3 kilometers) of leks during the time of day sage-grouse were present on leks influenced the number of males on leks more negatively than leks where roads within 1.86 miles (3 kilometers) had no vehicle activity during the strutting period. Lyon and Anderson (2003) reported that traffic disturbance (1 to 12 vehicles/day) within 1.86 miles (3 kilometers) of leks during the breeding season reduced nest-initiation rates and increased distances moved from leks during nest site selection of female sage-grouse breeding on those leks. Blickley et al. (2012) report that peak male attendance (i.e., abundance) at leks experimentally treated with noise recorded at roads in a natural gas field decreased 73% relative to paired controls; the authors found that the intermittent nature of noise from roads impacted male sage-grouse to a greater degree than more constant noise, such as that from a drilling rig.

---

## TRANSMISSION & POWERLINES

---

Results of sage-grouse research related to the development of the 345 kV Falcon to Gonder (FG) transmission line in Eureka County, NV has recently been synthesized and published (Gibson et al. 2018). This is the only study on sage-grouse to focus exclusively on powerlines and no previous study that has assessed impacts of powerlines has controlled for confounding effects of environmental variability, which was achieved due to the 10 year study period, large sample sizes of sage-grouse locations and vegetation measurement sites, and statistical analyses that isolated transmission line effects from other variables (e.g. sage-grouse habitat quality). The conclusions of this study tie an increase in ravens in the study area as causal factor related to avoidance of powerlines and decreased sage-grouse vital rates in the study area. The greatest driving factor behind the effects of powerlines is raven abundance. In years with more ravens (increased over time), the response was stronger. Nests located 12.5 km from the line had 0.06 to 0.14 higher probabilities of hatching compared to nests within 1 km of the line during years of average to high raven abundance. Gibson et al. (2018) also found that leks located 5 km from the line had a 0.02 to 0.16 higher rates of population growth compared to leks within 1 km of the line in years of average to high raven abundance. In addition, there was also support for downward trends in other vital rates including pre-fledgling chick survival, male survival, per capita recruitment, and population growth. Sage-grouse habitat avoidance from any power line was observed within 10 km and demographic suppression from the 345 kV Falcon-Gondor (FG) line was observed up to 12.5 km; combined these effects ultimately resulted in an overall negative association between the FG line and population growth rates to at least 5 km from the line.

Increases in raven abundance have been well documented across the west in relation to anthropogenic subsidies (i.e. landfills, road kill) and infrastructure, including transmission lines (Engel et al. 1992, Knight and Kawashima 1993, Steenhof et al. 1993, Knight et al. 1995, Webb et al. 2004, Kristan and Boarman 2007). Recent studies have provided additional support for the influence of transmission lines on raven occupancy and abundance. Coates et al. (2014) found that the probability of a raven nesting on anthropogenic structures was 80%, which consisted of transmission lines (53%), cooling towers, single radio-communication and cell towers (16.5%), and nesting platforms (4.1%). Bui et al. (2010) observed the probability of nesting ravens across two study sites in Wyoming ranged from 78% - 98% (90% average) within 400m of oil development, urban areas, and roads. Coates et al. (2014) observed effects of raven abundance in relation to powerlines out to 27 km; however, the probability of raven occurrence in relation to transmission lines had the most significant effect within approximately 2km of transmission lines, after which the impact was reduced substantially.

Ravens have also been identified as the primary nest predator of sage-grouse using nest videography in Nevada (Coates et al. 2008, Coates and Delehanty 2010, Lockyer et al. 2015). Bui et al. (2010) determined that sage-grouse nest survival in a Wyoming study was more affected by raven occupancy (e.g. resident nesting, territorial pairs) than raven density (e.g. non-territorial, nomadic individuals). These results suggest that breeding resident ravens were responsible for the majority of sage-grouse nest depredations and negatively affected local breeding population productivity in this study.

Knick et al. (2013) reported that leks were absent from 3.11 miles (5 kilometers) radius areas where transmission line and major power line densities exceeded 0.124 miles/square mile (0.20 kilometers/square kilometer). Wisdom et al. (2011) found that the mean distance to transmission lines using historical sage-grouse locations in extirpated range was approximately 6km compared to 15km for historical locations in currently occupied range. In other words, historical sage-grouse locations within 6km of transmission lines are now extirpated. LeBeau (2012) reported that sage-grouse avoided areas within 2.92 miles (4.7 kilometers) of transmission lines during brood-rearing, and that the probability of nest success and probability of female survival increased as distance to transmission line increased; but it is worth noting that the author found that brood-rearing and nesting sage-grouse selected areas nearer transmission lines in the control study area. Walker et al. (2007) reported that the probability of lek persistence decreased with proximity to power lines and with increasing proportion of power lines within

a 3.98 miles (6.4 kilometers) window around leks; but it is worth noting that distances to power line and power line densities as covariates were highly correlated with other gas development infrastructure covariates examined on the study site, and were not as good as predictors as gas wells. Dinkins et al. (2012) found evidence that female sage-grouse selected nest sites that had lower densities of ravens and raptors compared to random locations.

Other cited studies that may provide evidence of impacts of tall structures on sage-grouse include the following: Braun (1998) reported that sage-grouse avoided areas within 1,968.5 feet (600 meters) of transmission lines, but results were based on unpublished pellet survey data; Gillan et al. (2013) observed sage-grouse avoidance within 600m of transmission lines; and Hansen et al. (2016) showed that sage-grouse winter home ranges were negatively influenced by the presence of high voltage (345-500kv) transmission lines. Beck et al. (2009) reported that collisions with power lines accounted for 33% of juvenile sage-grouse winter mortality, but only 2 juvenile grouse were killed by running into power lines. Gibson et al. (2013, 2018) reported a negative effect of transmission line proximity on nest success for nests in high quality sage-grouse habitat and a negative effect of proximity to the line on female survival for females with generally lower survival. They did not find an avoidance of transmission lines by either males or females, but did find demographic effects.

Manier (2014) found for surface disturbances a literature minimum of 1 km (0.6 mi; Howe et al. 2014), literature maximum is 18 km (11.2 mi; Johnson et al. 2011), and interpreted range is 3.3 km (2 mi) to 8 km (5 mi).

Data from Wells Rural Electric Association (WREA) has provided data to allow further categorization of powerline subtypes. WREA data included nest observations associated with pole types (e.g. single pole, one cross arm, double cross arm, single or three phase, etc.). The SETT was able to compile the average number of nests per km of line within the WREA service area. WREA services 1,123 miles of single and three phase line and recorded 236 nests on those lines. An analysis of nests per structure type resulted in 11.2 nests per 100 miles of line for single phase and 34.7 nests per 100 miles of line for three phases, which is a 210% increase in frequency of nests on three phases compared to single phase. Single phase lines are all single poles with no cross arms (excluding transformers associated with single phase).

When three phase lines were further divided by structure type, there were differences among cross arm types. Single cross arm poles had a total of 9.6 nests per 100 miles of line and double cross arm poles had 24.7 nests per 100 miles of line. Single cross arm poles actually had a lower nesting frequency than single phase; however, all of single phase includes transformers, which attract nesting raptors and ravens. The double cross arm design had a 158% increase in nesting frequency compared to the single cross arm structure.

---

## TOWERS

---

Despite low numbers of communication towers across the sagebrush biome, sage-grouse lek trends across the range of the species generally decreased with distance to nearest communication tower and generally decreased with increasing numbers of towers within 3.11 miles (5 km) and 11.18 miles (18 kilometers) of leks (Johnson et al. 2011). The authors surmised that the response of sage-grouse to communication towers may be correlative to human development in general as these types of towers tend to be concentrated along major roadways and near urban centers; however, with the increase in these types of structures throughout the sagebrush biome (e.g., meteorological towers at proposed wind developments), it is worth considering the documented effects. Wisdom et al. (2011) found that the mean distance to cell towers using historical sage-grouse locations in extirpated range was approximately 12 km compared to 21 km for historical locations in currently occupied range.

In addition, more evidence indicates that impacts on sage-grouse from tall structures such as powerlines and other human infrastructure is due to predation from ravens and level of impact is relative to raven

abundance (Coates and Delehanty 2010, Bui et al. 2010, Dinkins et al. 2012, Coates et al. 2014, Gibson et al. 2016).

---

## URBAN DEVELOPMENT

---

Urban areas by themselves remove sage-grouse habitat and present inhospitable environments for sage-grouse, but the physical boundaries of cities are small relative to the total sagebrush area. However, people in cities require resources from surrounding areas, and the connecting roads, railways, power lines and communications corridors exert a greater influence on sagebrush ecosystems (Connelly et al. 2004). Additionally, recreation, including hiking, hunting and fishing, and off-highway vehicle use in areas surrounding urban centers can negatively influence sage-grouse through habitat loss and fragmentation, facilitation of exotic plant spread, animal displacement or avoidance, establishment of population barriers, or increased human-wildlife encounters that increase wildlife mortality (Connelly et al. 2004). Across the sage-grouse range, lek count trends were lower when human-footprint scores exceeded 2 at leks, or when median scores exceeded 3 within either 3.11 miles (5 kilometers) or 11.2 miles (18 kilometers) of a lek (Johnson et al. 2011). The human-footprint index was a measure of the totality of direct anthropogenic features – including human habitation, highways and roads, railroads, power lines, agricultural lands, campgrounds, rest stops, landfills, oil and gas developments, and human-induced fires – on a landscape expressed on a 1 to 10 scale (Johnson et al. 2011). Wisdom et al. (2011) reported that human density was 26 times lower in occupied sage-grouse range compared to historically occupied but currently extirpated range. Aldridge and Boyce (2007) found that brood-rearing females avoided areas associated with a high density of urban developments; it is worth noting that “urban” was defined as towns, farmsteads, and energy infrastructure in this study, however it is not the case in the Program.

Landfills are an important anthropogenic disturbance category; disturbances associated with landfills include traffic, equipment operation, etc., that produce noise and activity similar to what can be expected within urban areas. Landfills also can attract large concentrations of ravens. Ravens are very successful nest predators of sage-grouse, and anthropogenic food and perching subsidies such as landfills have been shown to attract large concentrations of ravens which can lead to increases in juvenile survival and local populations (Webb et al. 2004, Kristan and Boarman 2007); see Transmission and Powerlines section above for additional references). Due to the relatively close proximity of existing landfills and transfer stations to towns and communities and similar impacts to urban areas, this disturbance type is included within the Urban – Low disturbance category.

---

## LINEAR RIGHTS OF WAY

---

Other than transmission lines and roads, there is little science directly on how some linear features, such as pipelines or buried transmission lines, affect sage-grouse populations. However, looking at the components of what we would expect to find for pipelines, buried transmission lines, and other linear features, we would anticipate similar direct and indirect effects as the literature has shown roads and tall structures to have. There is direct surface area loss of sage-grouse habitat from the linear feature itself, whether above or below ground, as well as other infrastructure associated with the linear feature. Ground disturbance and potential for invasive species establishment and spread can be significant depending on the extent of ground disturbance, existing soil types, local environmental conditions, and other factors. In addition to direct impacts, there are potential indirect impacts from the spread of invasive species into surrounding areas, operation or traffic noise from maintenance of the linear feature, as well as from ravens and other birds of prey that may use above ground infrastructure for perching or nesting. Ravens and raptors may have more opportunities to use infrastructure that is accessible for either perching or nesting. Ravens are intelligent, visually cued predators that select edge-dominated or fragmented areas with changes in vegetation, particularly non-native vegetation (Coates et al. 2014); ravens therefore may be more likely to use linear ROW corridors that have either perching infrastructure or have significant ground disturbance that is largely removed of vegetation as well as cheatgrass establishment that provides access and opportunities for hunting and scavenging.

---

## OTHER DISTURBANCE

---

The Other Disturbance category is intended to capture miscellaneous, ancillary, and other types of disturbances that are analyzed as disturbances but do not fall into an existing CCS disturbance category. Examples could be hydroelectric power projects, gravel pits, mineral materials sites, certain renewable or non-renewable energy projects (excluding solar, wind, and geothermal), maintenance or transfer stations, staging areas, etc. There will be four Subtypes of Low, Medium, High, and No Indirect Disturbance. The No Indirect Disturbance subtype will capture areas of existing direct disturbance (i.e., homesteads, feed lots, historical disturbances) that will not have an indirect impact but contain areas of non-habitat.

The range of weights (0 - 75%) and distances (0 - 6km) for the Other Disturbance category incorporates the various indirect impacts associated with high vs low impacts. Proposed disturbances will be analyzed on a case-by-case basis to most appropriately categorize disturbances that will default to Other Disturbance; however, there will be some criteria used to help categorize proposed disturbances. The following criteria are based on previous anthropogenic disturbance categories and associated science and rationale included within this [Appendix 4](#).

## REFERENCES

---

- Aldridge, C., and M. Boyce. 2007. Linking occurrence and fitness to persistence: Habitat-based approach for endangered Greater Sage-Grouse. *Ecological Applications* 17:508–26.
- Balch, J. K., B. A. Bradley, C. M. D'Antonio, and J. Gómez-Dans. 2013. Introduced annual grass increases regional fire activity across the arid western USA (1980-2009). *Global Change Biology* 19:173–183.
- Beck, J., K. Reese, J. Connelly, and M. Lucia. 2009. Movements and Survival of Juvenile Greater Sage-Grouse in Southeastern Idaho. *Wildlife Society Bulletin* 34:1070–1078.
- Blickley, J., D. Blackwood, and G. Patricelli. 2012. Experimental evidence for the effects of chronic anthropogenic noise on abundance of Greater Sage-Grouse at leks. *Conservation Biology* 26.
- Blomberg, E. J., J. S. Sedinger, M. T. Atamian, and D. V. Nonne. 2012. Characteristics of climate and landscape disturbance influence the dynamics of greater sage-grouse populations. *Ecosphere* 3:55.
- Braun, C. 1998. Sage grouse declines in western North America: What are the problems? *Proceedings of the Western Association of State Fish and Wildlife Agencies* 78.
- Bui, T.-V., J. Marzluff, and B. Bedrosian. 2010. Common raven activity in relation to land use in western Wyoming: Implications for Greater Sage-Grouse reproductive success. *The Condor* 112:65–78.
- Bureau of Land Management. 2015. Nevada and northeastern California Greater Sage-grouse proposed land use plan amendment and environmental impact statement.
- Carpenter, J., C. Aldridge, and M. S. Boyce. 2010. Sage-Grouse habitat selection during winter in Alberta. *The Journal of Wildlife Management* 74:1806–1814.
- Casazza, M., P. Coates, and C. Overton. 2011. Linking habitat selection and brood success in Greater Sage-Grouse. Pages 151–167 *Ecology, Conservation, and Management of Grouse*. University of California Press.
- Coates, P. S., B. E. Brussee, M. A. Ricca, J. P. Severson, M. L. Casazza, K. B. Gustafson, S. P. Espinosa, S. C. Gardner, and D. J. Delehanty. 2020. Spatially explicit models of seasonal habitat for greater sage-grouse at broad spatial scales: Informing areas for management in Nevada and northeastern California. *Ecology and Evolution* 10:104–118.
- Coates, P. S., J. W. Connelly, and D. J. Delehanty. 2008. Predators of Greater Sage-Grouse nests identified by video monitoring. *Journal of Field Ornithology* 79:421–428.
- Coates, P. S., and D. J. Delehanty. 2010. Nest Predation of Greater Sage-Grouse in Relation to Microhabitat Factors and Predators. *The Journal of Wildlife Management* 74:240–248.
- Coates, P. S., K. B. Howe, M. L. Casazza, and D. J. Delehanty. 2014. Landscape alterations influence differential habitat use of nesting raptors and ravens within sagebrush ecosystem: implications for transmission line development. *Cooper Ornithological Society* 116:341–356.
- Coates, P. S., Z. B. Lockyer, M. A. Farinha, J. M. Sweeney, V. M. Johnson, M. G. Meshriy, Shawn P. Espinosa, D. J. Delehanty, and M. L. Casazza. 2011. Preliminary Analysis of Greater Sage-Grouse Reproduction in the Virginia Mountains of Northwestern Nevada. Page 32. Nevada Department of Wildlife, Idaho State University, U.S. Fish and Wildlife Service.
- Coates, P. S., B. G. Prochazka, M. A. Ricca, K. B. Gustafson, P. T. Ziegler, and M. L. Casazza. 2017. Pinyon and juniper encroachment into sagebrush ecosystems impacts distribution and survival of greater sage-grouse. *Rangeland Ecology and Management* 70:25–38.

- Colorado Division of Wildlife, Bureau of Land Management, and US Fish and Wildlife Service. 2008. Colorado Greater Sage-Grouse Conservation Plan.
- Connelly, J. W., S. T. Knick, C. E. Braun, W. L. Baker, E. A. Beever, T. Christiansen, K. E. Doherty, E. O. Garton, S. E. Hanser, D. H. Johnson, M. Leu, R. F. Miller, D. E. Naugle, S. J. Oyler-McCance, D. A. Pyke, K. P. Reese, M. A. Schroeder, S. J. Stiver, B. L. Walker, and M. J. Wisdom. 2011. Conservation of Greater Sage-Grouse: a synthesis of current trends and future management. Pages 549–564 in S. Knick and J. W. Connelly, editors. Greater Sage-Grouse: Ecology and Conservation of a Landscape Species and Its Habitats. University of California Press, Berkeley, CA.
- Connelly, J. W., S. T. Knick, M. A. Schroeder, and S. J. Stiver. 2004. Conservation assessment of greater sage-grouse and sagebrush habitats. Western Association of Fish and Wildlife Agencies, Cheyenne, Wyo.
- Connelly, J. W., K. P. Reese, E. O. Garton, and M. L. Commons-Kemner. 2003. Response of greater sage-grouse *Centrocercus urophasianus* populations to different levels of exploitation in Idaho, USA. *Wildlife Biology* 9:335–340.
- Connelly, J. W., M. A. Schroeder, A. R. Sands, and C. E. Braun. 2000. Guidelines to manage sage grouse populations and their habitats. *Wildlife Society Bulletin* 28:967–985.
- D'Antonio, C. M., and P. M. Vitousek. 1992. Biological invasions by exotic grasses, the grass/fire cycle, and global change. *Annual Review of Ecology, Evolution, and Systematics* 23:63–87.
- Davies, K., C. Boyd, J. Beck, J. Bates, T. Svejcar, and M. Gregg. 2011. Saving the sagebrush sea: An ecosystem conservation plan for big sagebrush plant communities. *Biological Conservation*:2573–2584.
- Dinkins, J. B., M. R. Conover, C. P. Kirol, and J. L. Beck. 2012. Greater Sage-Grouse (*Centrocercus urophasianus*) select nest sites and brood sites away from avian predators. *The Auk* 129:600–610.
- Doherty, K. E., D. E. Naugle, and J. S. Evans. 2010. A currency for offsetting energy development impacts: Horse-trading Sage-grouse on the open market. *PLOS ONE* 5:e10339.
- Doherty, K. E., D. E. Naugle, B. L. Walker, and J. M. Graham. 2008. Greater sage-grouse winter habitat selection and energy development. *Journal of Wildlife Management* 72:187–195.
- Dzialak, M. R., C. V. Olson, S. M. Harju, S. L. Webb, J. P. Mudd, J. B. Winstead, and L. D. Hayden-Wing. 2011. Identifying and prioritizing Greater Sage-grouse nesting and brood-rearing habitat for conservation in human-modified landscapes. *PLOS ONE* 6:e26273.
- Engel, K. A., L. S. Young, K. Steenhof, J. Roppe, and M. Kochert. 1992. Communal roosting of common ravens in southwestern Idaho. *The Wilson Bulletin* 104:105–121.
- Epanchin-Niell, R., J. Englin, and D. Nalle. 2009. Investing in rangeland restoration in the Arid West, USA: countering the effects of an invasive weed on the long-term fire cycle. *Journal of Environmental Management* 91:370–379.
- Farzan, S., D. J. N. Young, A. G. Dedrick, M. Hamilton, E. C. Porse, P. S. Coates, and G. Sampson. 2015. Western juniper management: assessing strategies for improving greater Sage-grouse habitat and rangeland productivity. *Environmental Management* 56:675–683.
- Fischer, R. A., K. P. Reese, and J. W. Connelly. 1996a. Influence of vegetal moisture content and nest fate on timing of female sage grouse migration. *The Condor* 98:868–872.
- Fischer, R., K. Reese, and J. Connelly. 1996b. An investigation on fire effects within xeric Sage grouse brood habitat. *Journal of Range Management* 49:194–198.
- Fuhlendorf, S. D., and F. E. Smeins. 1996. Spatial scale influence on longterm temporal patterns of a semi-arid grassland. *Landscape Ecology* 11:107–113.

- Fuhlendorf, S., A. Woodward, D. Leslie, and J. Shackford. 2002. Multi-scale effects of habitat loss and fragmentation on lesser prairie-chicken populations of the US Southern Great Plains. *Landscape Ecology* 17:617–628.
- Gibson, D., E. J. Blomberg, M. T. Atamian, S. P. Espinosa, and J. S. Sedinger. 2018. Effects of power lines on habitat use and demography of greater sage-grouse (*Centrocercus urophasianus*). *Wildlife Monographs* 200:1–41.
- Gibson, D., E. J. Blomberg, M. T. Atamian, and J. S. Sedinger. 2016. Nesting habitat selection influences nest and early offspring survival in Greater Sage-Grouse. *The Condor* 118:689–702.
- Gibson, D., E. Blomberg, G. Patricelli, A. Krakauer, M. Atamian, and J. Sedinger. 2013. Effects of radio collars on survival and lekking behavior of male Greater Sage-Grouse. *Ornithological Applications* 115:769–776.
- Gillan, J., E. Strand, J. Karl, K. Reese, and T. Laninga. 2013. Using spatial statistics and point-pattern simulations to assess the spatial dependency between Greater Sage-Grouse and anthropogenic features. *Wildlife Society Bulletin* 37.
- Hagen, C., J. Connelly, and M. Schroeder. 2009. A Meta-analysis of Greater Sage-grouse *Centrocercus urophasianus* nesting and brood-rearing habitats. *Wildlife Biology* 13:42–50.
- Hansen, E., A. Stewart, and S. Frey. 2016. Influence of transmission line construction on winter sage-grouse habitat use in southern Utah. *Human–Wildlife Interactions* 10.
- Harju, S. M., M. R. Dzialak, R. C. Taylor, L. D. Hayden-Wing, and J. B. Winstead. 2010. Thresholds and time lags in effects of energy development on Greater Sage-Grouse populations. *The Journal of Wildlife Management* 74:437–448.
- Hess, J. E., and J. L. Beck. 2012. Disturbance factors influencing greater sage-grouse lek abandonment in north-central Wyoming. *The Journal of Wildlife Management* 76:1625–1634.
- Holloran, M. J., and S. H. Anderson. 2005. Spatial distribution of Greater Sage-Grouse nests in relatively contiguous sagebrush habitats. *American Ornithological Society* 107:742–752.
- Holloran, M., R. KAISER, and W. Hubert. 2010. Yearling Greater Sage-Grouse Response to Energy Development in Wyoming. *The Journal of Wildlife Management* 74:65–72.
- Howe, K., P. Coates, and D. Delehanty. 2014. Selection of anthropogenic features and vegetation characteristics by nesting Common Ravens in the sagebrush ecosystem. *Ornithological Applications* 116:35–49.
- Johnson, D. H. 1980. The Comparison of Usage and Availability Measurements for Evaluating Resource Preference. *Ecology* 61:65–71.
- Johnson, D. H., M. J. Holloran, J. W. Connelly, S. E. Hanser, C. L. Amundson, and S. T. Knick. 2011. Influences of environmental and anthropogenic features on greater sage-grouse populations, 1997-2007. Pages 407–450 *Greater Sage-grouse: ecology and conservation of a landscape species and its habitats*. University of California Press.
- Kirol, C., P. 2012. Quantifying habitat importance for greater sage-grouse (*Centrocercus urophasianus*) population persistence in an energy development landscape. Thesis, University of Wyoming.
- Knick, S. T., and J. W. Connelly. 2011. *Greater Sage-Grouse: Ecology and conservation of a landscape species and Its habitats*. First edition. University of California Press.
- Knick, S. T., S. E. Hanser, and K. L. Preston. 2013. Modeling ecological minimum requirements for distribution of greater sage-grouse leks: implications for population connectivity across their western range, U.S.A. *Ecology and Evolution* 3:1539–1551.

- Knight, R. L., and J. Y. Kawashima. 1993. Responses of raven and red-tailed hawk populations to linear right-of-ways. *The Journal of wildlife management* 57:266–271.
- Knight, R. L., H. A. L. Knight, and R. J. Camp. 1995. Common ravens and number and type of linear rights-of-way. *Biological Conservation* 74:65.
- Kolada, E. J., M. L. Casazza, and J. S. Sedinger. 2009a. Ecological factors influencing nest survival of greater sage-grouse in Mono County, California. *Journal of Wildlife Management* 73:1341–1347.
- Kolada, E. J., J. S. Sedinger, and M. L. Casazza. 2009b. Nest site selection by greater sage-grouse in Mono County, California. *Journal of Wildlife Management* 73:1333–1340.
- Kristan, W. B., and W. I. Boarman. 2007. Effects of anthropogenic developments on common raven nesting biology in the West Mojave Desert. *Ecological Applications: A Publication of the Ecological Society of America* 17:1703–1713.
- LeBeau, C. 2012, April 18. Evaluation of Greater Sage-Grouse reproductive habitat and response to wind energy development in south-central, Wyoming.
- Lockyer, Z. B., P. S. Coates, M. L. Casazza, S. Espinosa, and D. J. Delehanty. 2015. Nest-site selection and reproductive success of greater sage-grouse in a fire-affected habitat of northwestern Nevada. *Journal of Wildlife Management* 79:785–797.
- Lyon, A. G., and S. H. Anderson. 2003. Potential gas development impacts on Sage Grouse nest initiation and movement. *Wildlife Society Bulletin (1973-2006)* 31:486–491.
- Manier, D. J. 2014. Conservation buffer distance estimates for greater Sage-Grouse: a review. U.S. Geological Survey, Reston, Virginia.
- Miller, R. F., S. T. Knick, D. A. Pyke, C. W. Meinke, S. E. Hanser, M. J. Wisdom, and A. L. Hild. 2011. CHAPTER TEN. Characteristics of sagebrush habitats and limitations to long-term conservation. Pages 145–184 in S. Knick and J. W. Connelly, editors. *Greater Sage-Grouse: Ecology and Conservation of a Landscape Species and Its Habitats*. University of California Press.
- Miller, R. F., R. J. Tausch, E. D. McArthur, D. D. Johnson, and S. C. Sanderson. 2008. Age structure and expansion of pinon-juniper woodlands: a regional perspective in the Intermountain West. Res. Pap. RMRS-RP-69. Fort Collins, CO: U.S. Department of Agriculture, Forest Service, Rocky Mountain Research Station. 15 p. 69.
- Milligan, M. C., P. S. Coates, S. T. O'Neil, B. E. Brussee, M. P. Chenaille, D. Friend, K. Steele, J. R. Small, T. S. Bowden, A. D. Kosic, and K. Miller. 2024. Greater sage-grouse habitat of Nevada and northeastern California—Integrating space use, habitat selection, and survival indices to guide areas for habitat management. Page Open-File Report. U.S. Geological Survey.
- Monsen, S. B. 2005. Restoration manual for Colorado sagebrush and associated shrubland communities. First edition. Colorado Division of Wildlife.
- Mooney, H. A., and E. E. Cleland. 2001. The evolutionary impact of invasive species. *Proceedings of the National Academy of Sciences* 98:5446–5451.
- Morrison, M., B. Marcot, and R. Mannan. 2007. Wildlife-habitat relationships: concepts and applications. *Journal of Range Management* 57.
- Naugle, D. E., K. E. Doherty, B. L. Walker, M. J. Holloran, and H. E. Copeland. 2011. Energy development and Greater Sage-Grouse. Page in S. Knick, editor. *Greater Sage-Grouse: Ecology and conservation of a landscape species and its habitats*. University of California Press.
- Open Standards for the Practice of Conservation. 2020. . v4.0.

- Orians, G. H., and J. F. Wittenberger. 1991. Spatial and temporal scales in habitat selection. *The American Naturalist* 137:S29–S49.
- Pyke, D. A. 2011. Restoring and rehabilitating sagebrush habitats. Pages 531–548 *Greater Sage-Grouse: Ecology and conservation of a landscape species and its habitats*. University of California Press, Berkeley, CA.
- Remington, T. E., and C. E. Braun. 1991. How surface coal mining affects sage grouse, North Park, Colorado. *Proceeding Issues and Technology in the Management of Impact Western Wildlife* 5:128–132.
- Rowland, M. M., L. H. Suring, and M. J. Wisdom. 2010. Assessment of habitat threats to shrublands in the Great Basin: a case study. Pages 673–685. *General Technical Report*, U.S. Forest Service, Bozeman, MT.
- Sandford, C. P., M. T. Kohl, T. A. Messmer, D. K. Dahlgren, A. Cook, and B. R. Wing. 2017. Greater Sage-Grouse resource selection drives reproductive fitness under a conifer removal strategy. *Rangeland Ecology & Management* 70:59–67.
- Seefeldt, S. S., and D. T. Booth. 2006. Measuring plant cover in sagebrush steppe rangelands: a comparison of methods. *Environmental Management* 37:703–711.
- Severson, J. P., C. A. Hagen, J. D. Tack, J. D. Maestas, D. E. Naugle, J. T. Forbes, and K. P. Reese. 2017. Better living through conifer removal: A demographic analysis of sage-grouse vital rates. *PLOS ONE* 12:e0174347.
- Smith, J. T., B. W. Allred, C. S. Boyd, J. C. Carlson, K. W. Davies, C. A. Hagen, D. E. Naugle, A. C. Olsen, and J. D. Tack. 2020. Are Sage-Grouse Fine-Scale Specialists or Shrub-Steppe Generalists? *The Journal of Wildlife Management* 84:759–774.
- Steenhof, K., M. N. Kochert, and J. A. Roppe. 1993. Nesting by raptors and common ravens on electrical transmission line towers. *The Journal of Wildlife Management* 57:271–281.
- Stiver, S. J., E. T. Rinkes, D. E. Naugle, P. D. Makela, D. A. Nance, and J. W. Karl. 2015. Sage-Grouse Habitat Assessment Framework: A Multiscale Assessment Tool. Technical Reference 6710-1, Bureau of Land Management and Western Association of Fish and Wildlife Agencies, Denver, Colorado.
- Tack, J. 2009, January 1. Sage-grouse and the human footprint: implications for conservation of small and declining populations. University of Montana.
- U.S. Fish and Wildlife Service. 2013. Greater Sage-grouse (*Centrocercus urophasianus*) conservation objectives: final report. U.S. Fish and Wildlife Service, Denver, CO.
- Van Horne, B. 1983. Density as a misleading indicator of habitat quality. *The Journal of Wildlife Management* 47:893–901.
- Vitousek, P. M. 1990. Biological invasions and ecosystem processes: towards an integration of population biology and ecosystem studies. *Oikos* 57:7–13.
- Walker, B. L., D. E. Naugle, and K. E. Doherty. 2007. Greater Sage-Grouse population response to energy development and habitat loss. *The Journal of Wildlife Management* 71:2644–2654.
- Webb, W. C., W. I. Boarman, and J. T. Rotenberry. 2004. Common raven juvenile survival in a human-augmented landscape. *Ornithological Applications* 106:517–528.
- Westover, M., J. Baxter, R. Baxter, C. Day, R. Jensen, S. Petersen, and R. Larsen. 2016. Assessing Greater Sage-Grouse selection of brood-rearing habitat using remotely-sensed imagery: Can readily available high-resolution imagery be used to identify brood-rearing habitat across a broad landscape? *PLOS ONE* 11:e0156290.

Wisdom, M. J., C. W. Meinke, S. T. Knick, and M. A. Schroeder. 2011. Factors associated with extirpation of sage-grouse. Pages 451–474 Greater Sage-Grouse: Ecology and conservation of a landscape species and Its habitats. University of California Press, Berkeley, CA.



For information and questions about the Nevada Conservation Credit System, please contact:

Sagebrush Ecosystem Technical Team (SETT)

(775) 687-2000